

Superconductivity and Electric Power: Promises, Promises...Past, Present and Future

Paul M. Grant
Electric Power Research Institute
Palo Alto, California USA

Abstract — The long-awaited marriage of superconductivity with electric power has undergone a lengthy engagement to say the least. Whether those nuptials will indeed ever take place is a question we here dare answer, recognizing full well the pitfalls entailed. Almost immediately after its 1911 discovery, superconductivity was popularly touted as the key to the lossless delivery of electricity...at least until the type I nature of these early materials was appreciated...a cycle of excitement and disillusionment that unfortunately has typified the field throughout its history. With the emergence and exploitation of Type II superconductors in the middle decades of the century, tremendous technical progress was made toward power application embodiments, resulting in operating prototypes of transmission cables and rotating machinery by the early 1980s. Nonetheless, these achievements did not mature into commercial power products, primarily because of economic and social factors that had evolved by that time...successful conservation efforts had lowered expected electricity load growth such that, ironically, the incremental efficiencies offered by superconductivity were no longer required at the cost involved...an important lesson in that the successful deployment of a technology often rests on factors unforeseen and outside its internal development. The years from 1986 to the present have witnessed the discovery of the copper oxide perovskite high temperature superconductors and their coming-of-age in practical wire form. These events, plus a renewed and growing world-wide demand for electric energy, give hope that the final vows will actually take place during the first quarter of the coming century.

I. INTRODUCTION

From the very earliest days following the experiments revealing zero resistance in mercury metal [1] cooled to the boiling point of liquid helium by Kamerlingh Onnes in 1911, a result he immediately and aptly named "superconductivity," the potential for this astounding phenomena to revolutionize our electric technology has been recognized. However, as the century of its discovery now comes to a close — many worthy and well-planned efforts notwithstanding — this potential remains essentially unfulfilled. By and large, the principal impediment to wide-spread application, especially those requiring operation over large distances or volumes, has been the necessity to employ complex and expensive refrigeration systems to produce and maintain the surrounding ultra-low temperature environment. For example, it has remained simply impractical to construct and operate economically superconducting electric power transmission cables over kilometer-scale lengths. Likewise, the application of superconducting

magnet technology to electric energy storage at levels comparable to pumped hydroelectric has eluded practical realization for similar reasons of refrigeration difficulties. It is true, on the other hand, that superconductivity has achieved modest commercial success in certain specialized markets such as medical magnetic resonance imaging. Nonetheless, such markets, as well as new opportunities for electric power generation, transmission, distribution and storage, would greatly expand were superconductors to be found that operate at substantially higher temperatures than those currently employed, and be amenable to development as practical and commercial electric wire. We emphasize this last remark as vital to any deployment of superconducting technology in the electric power industry. Wire is the commodity of electricity, itself becoming a commodity as well as deregulation and increased competition with the electric utility industry takes place.

A significant step forward took place with a series of discoveries beginning in 1986 [2] which continue to the present time. Previous to these events, the highest temperature below which superconductivity existed was about 21 K (-252 C), requiring a maximum operating temperature of 12-15 K. The newest [3] of these new materials, the so-called "high temperature superconductors (HTSC)," becomes superconducting at 133 K (-140 C), with an operating temperature near 90 K. Thus, we are now at the point where liquid nitrogen — cheap, plentiful, and environmentally friendly — or cryocoolers whose technology is in principle no more complicated than that employed in the ubiquitous and highly reliable residential refrigerator, can be employed for the application of superconductivity.

Before continuing further, it is useful to reflect somewhat on the vital role electricity plays in modern society. So many of us in the current generation grew up with an abundance of electric energy supply, we often forget its central position in our world today. A simple observation: consider how the invention of the electric light, which motivated the original economic impetus to develop centralized generation and distribution of electricity, advanced literacy and education in the United States at a time of enormous foreign immigration, simply by extending the number of hours available for study well into the night. Electricity may well be the reason America advanced to the status of a world power so quickly and equally so for Japan, whose electrification followed only a few years afterwards.

This scenario continues today. Figure 1 outlines the relationship between per capita gross domestic product and per

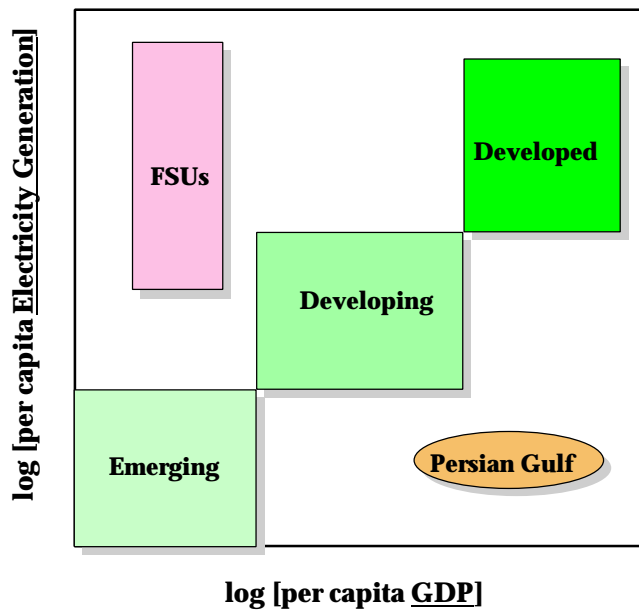
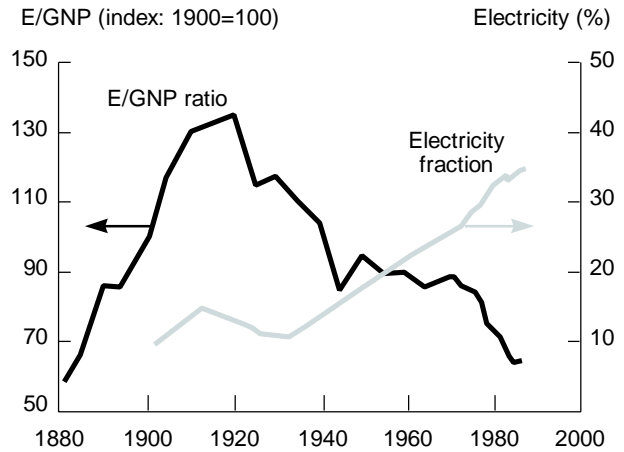

Fig. 1. Log per capita Electricity Generation vs. Log per capita GDP for a selection of nations ranging from emerging to developed. E.g., the US and Japan are in the right hand upper corner of “developed,” while Mexico and Russia and the former Eastern Bloc typify “developing,” and China, India, Central Africa and the smaller American states fall in the “emerging” category. Those countries outside the trend are the Persian Gulf states whose per capita GDP is high due to exploitation of vast petroleum reserves, and the former soviet states outside Russia with large generation capacity previously supplying the current Russian Republic.

capita electric power generation. Clearly, standard of living, as measured by a nation’s per capita GDP, directly depends on electricity generation and consumption.

The larger electric power consumption by those in the developed world does not imply excessive energy waste. Quite the contrary. As the proportion of energy consumption that is electric in end use increases, the more efficient the overall energy use of that society becomes. This point is amply illustrated in Fig. 2. The curves demonstrate that as the fraction of energy use in a society, in this case the United States, represented by electricity rises, the per capita energy consumption decreases. Electricity is a premium form of energy and represents the most efficient means of its use. Its pervasiveness and vitality within a modern industrial society is indicated impressively by the data in Fig. 3.

Figure 3 also implicitly reveals the central elements of an electrical culture – generation and storage, transmission and distribution, and end use – the Electricity Paradigm. The paradigm applies to the implementation of electric power technology to all human habitats, be they a community – village, city, state, nation, continent, planet...the more usual scenario – or more isolated such as within one’s automobile, ship, plane or spacecraft. With regard to superconductivity, the main opportunities for application generally lie inside the larger communal habitat. These are summarized in Fig. 4.



Source: Electricity in the American Economy, Sam H. Schurr, et al., 1990

Fig.2. Energy consumption normalized to GNP and electricity fraction thereof vs. Year for the United States over the last 120 years..

The remainder of this paper will treat each of these elements and application in historical perspective, concentrating on selected power projects most illustrative of a particular period. We will not discuss in any detail research magnet applications, e.g., accelerator beam confinement magnets, except as they might apply to a power applications, such as superconducting magnetic energy storage.

The North American Electric Power System

In excess of:

- ❖ **10000 Generating Units**
- ❖ **700 GW Capacity**
- ❖ **150,000 Miles of High Voltage Transmission**
- ❖ **1,000,000 Miles of Distribution (< 65 kV)**
- ❖ **300,000,000 Customers**
- ❖ **200 G\$ Annual Sales**

The World’s Largest Machine!

Fig. 3. Statistics (c. 1986) emphasizing the immense nature of the North American power generation, transmission and distribution system, both physically and economically.

The Electricity Paradigm and Superconductivity

- ❖ Generation/Storage
 - Generators
 - SMES
 - Flywheels
- ❖ Transmission/Distribution
 - Cables
 - Transformers
 - Fault Current Limiters
- ❖ End Use
 - Motors
 - Magnets
 - Transportation

Fig. 4. Application opportunities for superconductivity as components of the Electricity Paradigm.

II. PAST

Dreams of applying the new phenomenon to electric power emerged shortly after its discovery by Kamerlingh Onnes. The limitations of the early materials under conditions of even moderate amounts of current and magnetic fields quickly dispelled such hopes.

Fortunately, superconductors, as was later found, can come in two flavors, type I and type II, depending on their behavior in magnetic field. The discovery of type II superconductors [4] in the decades following World War II opened the door to the possibility of significant power applications. The difference in magnetic properties between the two flavors is shown schematically in Fig. 5 below.

Both types, at sufficiently low temperatures and fields below H_{C1} , will completely shield an externally applied magnetic field. Moreover, both will completely expel an internal field of strength below H_{C1} which was applied above the critical temperature, T_C , as they are cooled below it – the well-known manifestation of the Meissner effect. In a type I superconductor, this is all that happens, H_{C1} is a single critical field, H_C , which also primarily defines J_C , the maximum current density such a superconductor can sustain. Typically, H_C is a few hundred oersteds, J_C a few tens of amperes per square centimeter, and T_C in the single digit degree Kelvin range, not very practical levels for power uses.

On the other hand, nearly all superconductors with $T_C > 10$ K are of type II. In type II materials, magnetic fields greater than H_C (H_{C1} in Fig. 5) are neither completely expelled from nor completely pervade the volume of the superconductor. Instead, magnetic flux penetrates through many small tubes of radius approximately the paired electron coherence length, ξ .

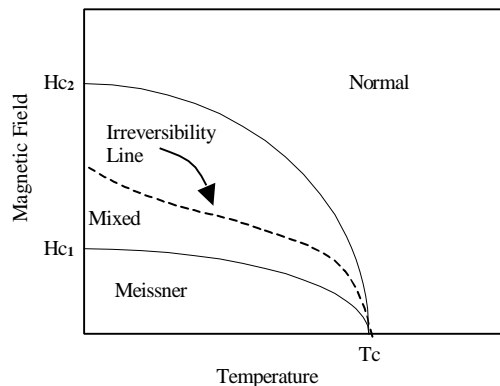

Fig. 5. Critical behavior of superconductors in applied magnetic field as a function of temperature.

whose volume is thus in the normal state, separated by superconducting regions of the order of the London penetration depth, λ . In fact, the ratio $\kappa \equiv \lambda/\xi$ essentially determines whether a material is type I (κ roughly less than unity) or type II ($\kappa > 1/\sqrt{2}$). Each tube, or vortex, contains one quantum of magnetic flux, Φ_0 , the collection of which form a periodic lattice, the Abrikosov vortex lattice. As the applied field increases, so do the number of vortices until a field of order $H_{C2} \approx \Phi_0/\xi$ is reached at which the superconductor volume can contain no more and thus enters the normal state. For obvious reasons, the region between the “lower” and “upper” critical fields in a type II superconductor is called the “mixed” state. H_{C2} at low temperatures can be enormous, of the order of a hundred tesla for high temperature superconductors.

Critical current density determining factors in the mixed state are complex and, by and large, extrinsic in nature. The vortices formed by the self-field of a flowing current are perpendicular to that current and thus experience a sideways Lorentz force in the direction of and proportional to the magnitude of the vector product of the current and vortex field. This force produces vortex motion which results in frictional energy loss and therefore electrical resistance. *Thus, a type II superconductor in the mixed state fundamentally cannot transport electrical current losslessly.* However, as the vortices move, some become trapped or “pinned” at various material impurity or defect sites. Due to the repulsive force between vortices, pinning only a few freezes the motion of the entire lattice and the lossless state is thus restored, but for direct current only, and only below a certain field as a function of temperature known as the “irreversibility” line, whose typical behavior is shown in Fig. 5. Below H_{IRR} , upon current polarity reversal, some pinned vortices remain as the current passes through zero. These vortices result in a “trapped flux” remaining in the superconductor quite analogous to the remnant field of a ferromagnet. Thus, under alternating current conditions, a type II superconductor experiences hysteresis, again similar to the same effect in a soft ferromagnet, which produces energy dissipation. In summary, due to both vortex motion and hysteresis, transport of ac power in a type II superconductor in the mixed state is *never* without loss.

These basic physical attributes of type II superconductors dominate all power applications. The discovery of high temperature superconductivity, arguably the very epitome of type II superconductors, only magnified the importance of understanding vortex dynamics. In fact, due to the low-dimensional nature of both their physical and electronic structure, and the higher operating temperature, losses due to flux motion are relatively higher than for low- T_C (LTSC) materials.

One final remark – how to produce extrinsic vortex pinning sites in a type II superconductor is at the heart of superconductor materials science, yet to this day remains pretty much a “black art,” ranging from standard metallurgical processing to, in the case of high- T_C , bombardment with energetic fundamental particles.

A. LTSC Wire Materials

Practical materials suitable for wire processing began to emerge in the 1960s with the development of various Nb-alloys, notably Nb_3Sn ($T_C \approx 18$ K) [5], Nb-Zr [6] culminating with the realization of the high- H_{C2} Nb-Ti ($T_C \approx 10$ K) [7] alloys. The first and the last are the mainstays of present low- T_C (LTSC) wire technology. However, there are significant processing differences between these materials – Nb-Ti has mechanical properties akin to usual metals, i.e., it is more or less readily malleable and ductile, whereas Nb_3Sn is a member A-15 family of and brittle in nature.

B. LTSC Wires and Tapes

A discussion of the practical issues involved in manufacturing wires and tapes from Nb_3Sn and Nb-Ti can be found in the book by Sheahen [8]. Here we will summarize the main points to be considered for these two compounds.

1) *Nb₃Sn*: Due to its higher T_C , H_{C2} and J_C compared to Nb-Ti, Nb_3Sn has undergone much effort in the 30-odd years since its discovery to develop a economically practical method of manufacturing. The standard technique embeds Nb filaments in Cu-Sn bronze or in Cu supplied by separate Sn reservoirs. Thus the multifilamentary wire or magnet can be prepared while all components are ductile, firing at $\sim 700^\circ\text{C}$ being the last Nb_3Sn formation step. Certain methods of forming electromagnets with HTSC also follow this philosophy, known as “wind-and-react”. Nb_3Sn laboratory research magnets are widely available, and, as we shall see, the Brookhaven cable project employed this compound also. Nb_3Sn tapes are also used in the recently announced Magnetic Resonance Therapy unit manufactured by General Electric.

2) *Nb-Ti*: Despite its inferior superconducting properties relative to Nb_3Sn , Nb-Ti wire has attracted over 90% of the superconducting wire market because of its more tractable mechanical properties. Generally, a procedure is followed superficially similar to that for Nb_3Sn – pre-alloyed Nb-Ti strands are embedded in a copper matrix, then drawn into

wire, and wound into whatever final form dictated by the application. No final anneal is necessary. Most MRI magnets are made with Nb-Ti wire, and it is the material of choice for particle collider confinement electromagnets. Currently, Nb-Ti wire can be manufactured with a J_C in excess of 300,000 A/cm² in a 5 T field in liquid helium.

Special requirements are needed for particular applications. For example, the component strands containing the LTSC can be twisted prior to drawing to reduce inductive coupling for ac applications, and the wire or tape coated with a high thermal conductivity metal, such as copper, to aid in quench propagation.

C. Rotating Machinery

Superconductivity applied to rotating electrical machinery has held a number of attractions. The principal component target has always been the rotor – stator ac losses have been deemed too severe to sustain. Mechanical motion with respect to a rotating magnetic field is relative and test models have been constructed where the rotor/stator role was reversed. However, such designs open complications which are greater than the disadvantage of supplying cryogen to a rotating framework.

Although efficiency of operation is an obvious feature of almost any superconducting device, this aspect is of less importance in rotating machinery, especially generators, than one might suspect. Very large motors and generators hover around 98% electromechanical efficiencies – devices attached to them, e.g., combustion turbines, fans, pumps, are far less efficient. Reduction in footprint and weight due to the higher rotor magnetic fields attainable, and improved response to fault current conditions, represent the more attractive features supplied by a superconducting rotor.

Perhaps the most ambitious rotating machinery project undertaken to date was the EPRI - Westinghouse 300 MVA generator study [9] carried out during 1981-83 which was to use a stator wound with Nb-Ti wire kept at 5 K. This effort was to be a feasibility study directed toward the eventual manufacture of units 1000-4000 MVA in capacity, a size at which the superconducting components would represent only 5% of the total cost. Generators of this magnitude only make economic sense in the context of nuclear power plants, although a few 1000 MVA units are fossil fuel combustion driven. The EPRI-Westinghouse project was canceled in midstream, not for technical or even cost reasons (it was to be a 30 M\$ project), but nuclear plant construction had stagnated, necessitating a re-investment in clean fossil combustion technology, such as fluidized coal beds and sulfur dioxide fixation. In addition, electrical load growth in the United States was projected to be slow for many decades and there was some uneasiness among the utilities about the exposure to having a single 4000 MVA power plant suddenly go off-line.

In 1988 the Japanese government, through the Ministry of International Trade and Industry (MITI), began a long-term generator development [10] program which was designated

“Super-GM,” the “GM” standing for “Generator/Materials.” This was to be a coordinated effort in both engineering design and materials improvement involving a consortium of Japan’s major heavy electrical equipment manufacturers and superconducting wire producers, initially to be based on existing low- T_C Nb-Ti wire technology. A two phase program was organized, the first phase to construct a 70 MVA unit to test three rotor designs to optimize performance for ac losses, high magnetic field and dynamic response, respectively. Within the last several months, a test site has been completed at a facility of the Kansai Electric Power Company (there are no current plans to connect the test site to an operating electrical grid). A second phase, involving scale-up to 200 MVA and possibly to employ high- T_C technology, is scheduled to start this year. However, the entire Super-GM program is under review and a positive decision to proceed to phase II has not yet been reached. About 30% of electricity generated in Japan is nuclear in origin, and the government has plans to expand the number of plants. There is some indication of political resistance to this move which may affect the future of Super-GM. As just pointed out, superconductivity makes most economic sense applied to large generators of the kind found in nuclear power stations.

D Power Cables

For most of the lay public, electric power cables come most quickly to mind when they hear about superconductivity in the context of “perfect” conductivity. Somehow, the vision of something-for-nothing is irresistible, and I’m frequently asked, “How is that possible? Wouldn’t that be a perpetual motion machine?” The answer, of course, is no. One does proper homage to the Second Law in generation and end use. However, it is this aspect of superconductivity, the prospect of lossless power transmission, which certainly accounted for the public attention garnered by the ac superconducting cable project [11] at Brookhaven National Laboratories in the decade spanning 1975-85. The general design of the “Brookhaven cable” is shown in Fig. 6. This project was jointly supported by the DOE and the Philadelphia Electric Company.

This project, much like the later EPRI-Westinghouse generator effort, had its motivation in servicing a rapidly expanding American load requirement in the period preceding the oil embargoes, concern for the environment, and the general feeling that “less is better” that came to characterize the have been an economic success in the aggressive load growth scenarios that prompted its initiation. Additionally, the “nuclear scenario” was also a motivating factor, and, as stated above with respect to the EPRI-Westinghouse generator project, no longer had credibility. However, much was learned, particularly that ac losses in superconducting power

135 kV, 1000 MVA, 3f, 115 m

Nb_3Sn , 7-9 K

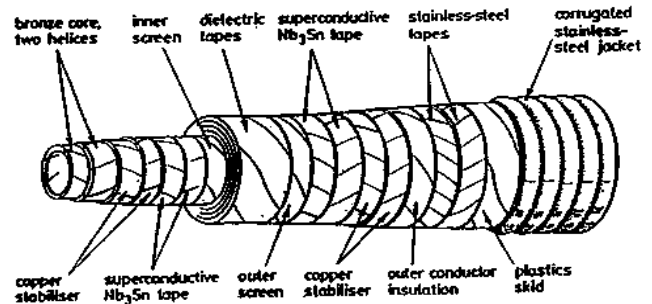

Fig. 6. Breakaway diagram of the composition of the Brookhaven cable. This was a coaxial design, consisting of a central conductor enclosed in a superconducting shield to reduce eddy current and other ac losses in the surrounding addenda.

cables were a very complex matter indeed, depending in unexpected ways on number of Nb_3Sn tape layers and manner of placement. We are learning the same lessons again in HTSC ac cables.

Roughly overlapping in time the Brookhaven ac cable project was a dc cable effort at the Los Alamos National Laboratory [12]. In principle, the stresses on the superconducting state in a dc cable are far less than for ac, because near-lossless operation is more approachable. Nevertheless, there still will occur hysteretic losses arising from inevitable ripple due to converter/inverter transition from ac to dc and back at the generation and load terminals. Moderation of such losses may involve considerable additional investment in power electronics and filter support. Like Brookhaven, this work was partially motivated by utility curiosity in technology capable of wheeling huge amounts of power in an urban environment. Unlike Brookhaven, the program was terminated before construction of a prototype was possible. However, the engineering design study is proving useful in examining dc cable concepts in the context of high temperature superconductors, a subject which we will take up later in this paper.

III. PRESENT

A. HTSC Wire Materials

As in the Past, the Present wire technology depends on the availability of suitably processible materials, in this case the new copper oxide perovskites. There are now well over 100 separate HTSC compounds differentiated by atomic structure and elemental content. Figure 8 charts progress in superconducting materials in terms of transition temperature since their initial discovery in 1911 up to the present era.

100 kV, 50 kA, 5000 MW, 300 m

Nb_3Sn , 10 K, 16 Atm

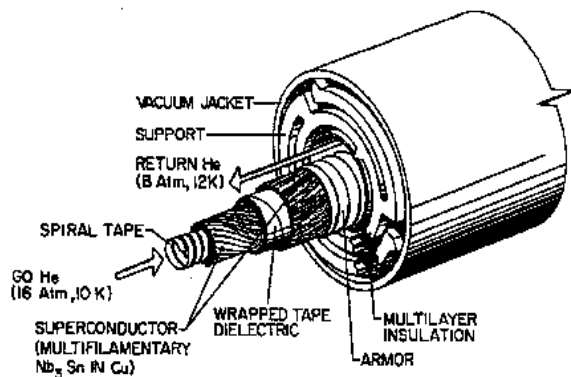

Fig. 7. Schematic of the LANL dc cable. Note the use of He at elevated temperatures and pressures compared to the Brookhaven ac cable.

The unifying feature of all HTSC compounds is the presence of a clearly identifiable square-planar network of copper and oxygen ions, generically termed “layered copper oxide perovskites [13].” This network has turned out to be a necessary, and almost sufficient, condition for the occurrence of high temperature superconductivity in copper oxides. In the last several years, three non-copper oxide compounds have been discovered with transition temperatures between 20 - 30 K, but so far have not shown promise of being extendible to higher temperatures [14]. Before going further, we need to point out that there is no generally accepted theory to explain the extraordinary properties of the copper oxide superconductors. All low temperature superconductors, with a few

exotic exceptions containing actinide elements or organic complexes which are still in question, involve the thermal vibrations (phonons) of the atomic lattice in supporting the superconducting state. Enigmatically, these thermal vibrations, the source of ordinary electrical resistance and energy loss accompanying the flow of electrons in a metal, actually help produce the superconducting state at sufficiently low temperatures. The explanation of this strange state of affairs was published in 1957 by Bardeen, Cooper and Schrieffer [15], and is known as the BCS theory, one of the most elegant accomplishments of 20th century science. In the original and extended forms of this theory, the lattice phonons can act to bind pairs of electrons together strongly enough to withstand collisions with this same lattice up to a theoretical maximum of 30 - 40 K, thus allowing the lossless flow of current at temperatures below this limit. It has long been known that other sorts of “quasiparticles” that can occur in materials, other than phonons, could possibly more strongly pair electrons within the BCS framework, producing substantially higher transition temperatures, perhaps as high as room temperature. Much intellectual energy has gone into the search for a new “pairing mechanism” to explain the occurrence of high temperature superconductivity in the cuprate perovskites. This has turned out to be a very contentious endeavor with no universally accepted picture having yet emerged. However, several competing approaches contain as a common element the recognition that electrons in the HTSC materials also interact magnetically, and that this interaction may be indeed the strong “glue” producing electron pairs that persist to the observed high temperatures [16]. Currently, the experimental and theoretical efforts are focused on determining the “symmetry” of the wave function of the superconducting pair. Phonon coupling typically produces pairs having “s-wave” symmetry, that is, similar to the lowest energy orbit of the electron in a hydrogen atom. If a magnetic interaction is involved, it could be expected to result in “d-wave” symmetry, inasmuch as that is analogous to that of the electron orbits in metals like iron and cobalt, and the copper ions in HTSC materials, that produce their magnetic behavior.

However, it should be pointed out that, despite the elegance of the BCS theory and its derivatives, it has not proven a very useful guide for the discovery of new superconducting materials. It is a beautiful framework with which to classify discoveries a posteriori, but historically new superconductors have appeared more or less serendipitously, and it is unlikely that this situation will change when an appropriate explanation for the HTSC materials evolves. The opening statement of the Bednorz-Mueller paper [2], “At the extreme forefront of research in superconductivity is the *empirical* search for new materials...,” still remains the most cogent advice to those seeking the next materials breakthrough. The principal copper oxide material systems which carry potential for wire application are shown in Fig. 9. On the left is displayed the crystal structure of $YBa_2Cu_3O_7$, nicknamed “Y-123” after

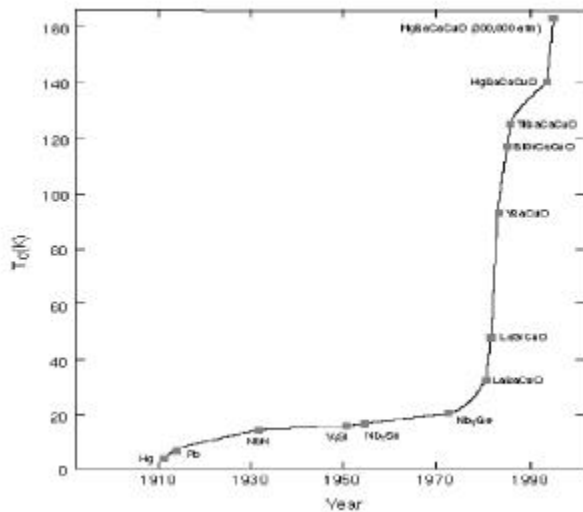

Fig. 8. Progress in raising the superconducting transition, T_c , from the year of its discovery to the present.

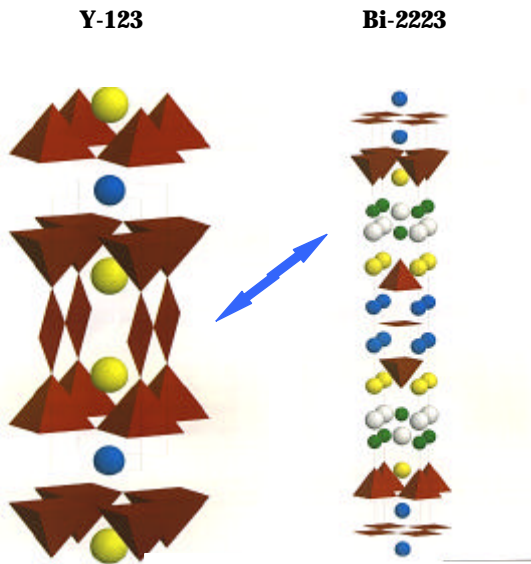

Fig. 9. Crystal structures of Y-123 and Bi-2223 [14], two of the most promising HTSC candidates for practical wire material. The dark squares and pyramids denote copper-oxygen coordination. The connecting arrows designate the respective interplanar arrangements which determine the nature of both processing and magnetic anisotropy in the two materials.

its cation ratio, or “YBCO,” an acronym based on the initials of its constituent elements, and on the right that of $\text{Bi}_2\text{Sr}_2\text{Ca}_2\text{Cu}_3\text{O}_{10}$, Bi-2223 or BSCCO. Both conventions are extensively employed in the technical literature on HTSC materials. YBCO was the first HTSC to display a transition temperature above the boiling point of liquid nitrogen [17], the long-sought “holy grail” of superconducting materials, and the story of its discovery is eloquently chronicled by Paul Chu in an adjoining article in this journal issue [18]. The discovery set off a frenetic flurry of activity in early 1987 which culminated in the famous all-night session, the “Woodstock of Physics,” at the March Meeting of the American Physical Society in New York City that year [19].

In both unit cells, the square-planar aspect of the copper oxide coordination can easily be seen. The Bi-2223 structure is part of a family of several other HTSC compounds where bismuth is replaced by thallium, mercury (with different oxygen coordination) and partially by lead. In some cases, the double layer of these metal oxides can be reduced to a single one (“1223”). The presence of this intermetallic oxide zone separating the copper oxide complex results in the BSCCO family having quite micaceous, or clay-like, mechanical properties, important for wire processing as will be discussed subsequently. On the other hand, in Y-123, the CuO planar complex is separated by a secondary, and, with regard to superconductivity, passive, linear copper oxide structure shown in Fig. 9 between the barium ions. These copper oxide “chains” provide much stronger bonding (i.e., increased dimensionality) between the active CuO planes in YBCO, than the intermetallic oxides in Bi-2223 family. This structural aspect is prosaically, yet strikingly, manifested when one grinds Bi-2223 and Y-123 in a mortar and pestle... the former

yields a “greasy” graphitic feel and the latter a very granular one like trying to grind sand.

Some of the other Bi-2223-like structures that are candidates for wire embodiments are Tl-1223 [20], Bi-2212 [21] and Hg-1223 [22] which have successfully been fabricated on Ag tape substrates. In particular, Bi-2212 shows great promise as wire for low-temperature magnet application at liquid He because of its very high H_{C2} . The synthesis of Bi-2212 from its oxide precursors produces significantly fewer secondary phases than the other candidates (except Y-123), making this material amenable to simpler manufacturing techniques such as dip-coating the precursors on Ag with subsequent thermal post-processing.

In Part I we briefly discussed the importance of the Abrikosov vortex lattice of type II superconductors and its influence on their practical properties. The high anisotropy of HTSCs plays a large role in their resulting vortex dynamics which are substantially different than the largely cubic LTSCs. It is also an area of current intense investigation, both basic and applied, in HTSC materials, and one which has generated almost as much controversy as the search for the pairing mechanism. In particular, a given material’s “irreversibility line,” (see Part I), is its defining feature for dc current and consequent electromagnet applications in generators, motors, energy storage and power quality for electric utilities and numerous end-use devices for their customers. To place the various materials in perspective as to the relative robustness of their lossless dc conductivity in magnetic field, we plot in Fig. 10 H_{IRR} vs. temperature for a likely selection of wire candidates.

We see in Fig. 10 a wide variation in H_{IRR} behavior from compound to compound, and especially note that those materials with the highest transition temperatures do not necessarily yield the highest irreversibility field at liquid nitrogen temperature, roughly the operating point of choice for a number of power applications. This variation is a consequence of unit cell dimensionality, the point on which we began our discussion. Unlike low temperature type II superconductors, almost all of which have cubic and isotropic structures, HTSC materials are highly anisotropic due to the two-dimensional character of the CuO planes. This 2D character greatly affects the overall vortex pinning properties. Imagine the cylindrical vortex tube as a long length of dry spaghetti, but with “wet” segments between the copper oxide planar complexes. The entire tube could be pinned simply by an impurity or defect located at one of the “dry” regions. The wet segments would represent the regions of the BiO planes in Bi-2223 or the corresponding Y-123 copper oxide chains in Fig. 9. However, for the same structural bonding reasons discussed earlier, these segments would be “wetter” or softer in the former than the latter. The irreversibility characteristic of HTSC materials is determined by the temperatures and fields required to break these weak segments in the vortex tube, resulting in little dry pieces of vortex spaghetti which themselves are unpinned and whose motion creates resistance. Although overly simplistic, the “wet spaghetti”

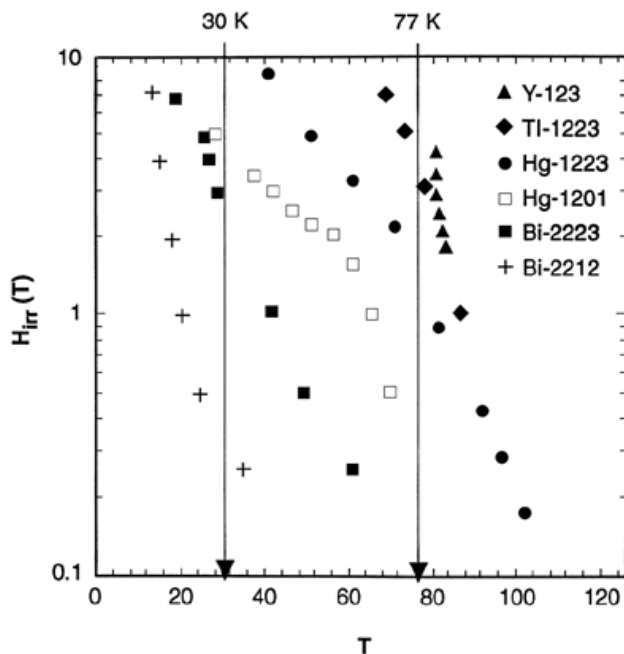

Fig. 10. Irreversibility field vs. temperature for a number of HTSC materials for potential wire application [23].

picture nonetheless fundamentally illustrates why the irreversibility line of Y-123 is so robust.

It is worth mentioning some recent attempts to improve extrinsic pinning by creating splay defects through bombardment of Bi-2223 [24] and Hg-1212 [25] by high energy protons. At their respective cross-section resonance absorption energies, both Bi and Hg undergo spontaneous fission with pinning centers created by the resulting fission fragments significantly enhancing H_{IRR} . In the case of Hg-1212, a record level of irreversibility field was achieved under bombardment with 800 GeV protons [25], energies sufficiently high to attain meter-scale penetration depths. One might well ask how practical this approach this may be, given the requirement for proton accelerators of the variety used to produce weapons-quantity tritium! The answer is that smaller-scale, room-sized proton acceleration chambers can be envisioned, not requiring purely monochromatic beams, that could be utilized to irradiate preformed electromagnets, targeted to special purpose applications such as insertion coils in high-field magnets, much in the spirit of “wind-and-react” techniques (vide infra).

B. HTSC Wires and Tapes

We re-emphasize that essentially every application of superconductivity to electric power technology depends on the successful development of suitable wire. Progress toward this end using the new HTSC materials has progressed much more rapidly in the last 10 years despite what at first appeared to be an improbability given the universally poor (one might say “non-”) ductility of ceramic materials. Such progress has occurred for a number of reasons, not the least of which has been the extraordinarily large number of materials scientists drawn to HTSC research, as well as some unanticipated “gifts

of nature.” In the latter category falls the relative ease of processing copper oxide perovskites in the presence of silver. In common with low temperature superconductors, the granularity and marginal ductility of the HTSC ceramics require the use of either a binder or sheath as an element of wire embodiment. Unfortunately, otherwise attractive common metals such as copper and aluminum have unfavorable phase equilibrium properties in contact with copper oxide materials. Only silver has been found to have suitable equilibrium properties at temperatures which the copper perovskites must be processed as well as possessing high oxygen diffusivity, also necessary for wire processing as will be seen shortly. In addition, Ag appears to aid in the stabilization and grain alignment of crystallographically single phase material, and is thus currently the platform material of choice for HTSC wire technology [26].

1) *Generation I -- BSCCO/Ag OPIT*: The central elements involved in manufacturing HTSC wire by the oxide-powder-in-tube method (OPIT) are outlined in Fig. 11. This is the process of choice for many of the BiO-based copper oxide perovskites. Metal oxide precursors of the respective elements (carbonates of Sr and Ca are used because of the general instability of oxides of these alkaline earth metals in air) of the constituent cations are mixed and reacted (calcined) at the temperatures ranging over 800-850 C, usually undergoing several cycles of regrinding and reheating, to produce a cation-stoichiometric powder of the target compound. An alternative or additional step is to include ball-milled or “mechanically-alloyed” metallic powders of the cation constituents. The powder resulting from either approach is then tightly packed into a cylindrical silver billet as shown. The filled billet next undergoes repeated draw/swage operations, using equipment almost identical to that employed for common wire production, until an overall diameter of about 1 mm or less is obtained. Several tens to over a hundred of these filaments are then rolled together to form a tape of the order 4-6 mm wide by <1 mm thick. A final step is to wind a given length of tape on a mandrill (spool) and the entire as-

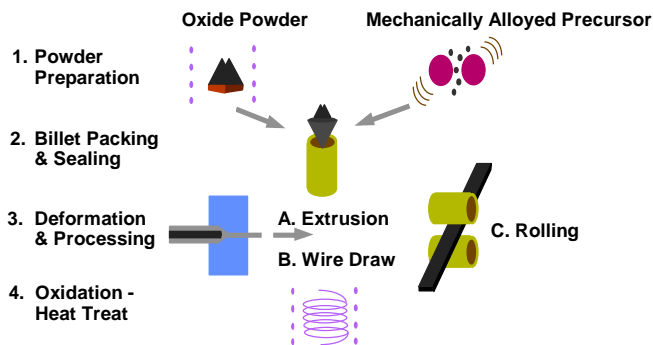

Fig. 11. Generic processing steps for the oxide-powder-in-tube (OPIT) method of preparing HTSC wire and tapes. Figure courtesy of American Superconductor Corporation.

sembly is then annealed for several days under oxygen atmosphere. This is the “react and wind” method – an alternative is to defer partially the final reaction and anneal until after the

tape is formed into its eventual shape, or “wind and react,” as in the Nb₃Sn process.

At present, a number of companies, American Superconductor, Intermagnetics General, Siemens, Sumitomo Electric and Furakawa Cable among them, have refined the OPIT process to the state where tapes of kilometer length containing several hundred BiO-based copper oxide filaments are now being routinely made. As hinted earlier, the micaceous nature of the intermetallic oxide layer is one of the keys to the success of the OPIT approach, as the draw/swage/roll process shears the material along this intergrowth like spreading out a deck of playing cards, producing an unexpectedly high degree of crystallographic alignment of the copper oxide planes from an originally random powder. This reduction in anisotropy results in significantly improved critical current. In addition, a quasi-melt processing phenomenon, still not completely understood, aids in the texturization process. It is found that most of the critical current flows within several microns of the Ag-HTSC interface.

In Fig. 12 we show a typical cross-section of multifilament OPIT/Ag tape. At present, such tapes can be reliably manufactured in kilometer-scale lengths.

We just discussed how the presence of Ag aids in the formation of a quasi-textured layer of HTSC in immediate contact, that layer carrying the bulk of the critical current. In an attempt to capitalize on this effect, a group at the Argonne National Laboratory has developed a geometry in which a silver thread is “inserted” in the middle of each filament [27],

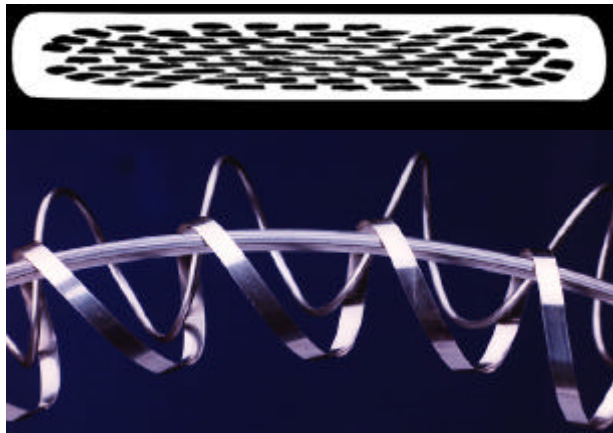

Fig. 12. Top: Cross-section of rolled and processed Bi-2223 OPIT/Ag tape containing 85 filaments of Bi-2223 (dark elongated shapes). Dimensions are approximately 5 mm by 0.5 mm. Bottom: Photograph of coiled OPIT/Ag tape indicating its highly flexible nature. Diameter of coil is approximately 3 cm. Photos courtesy of American Superconductor Corporation.

in the hope that increasing the effective area in contact with the HTSC will result in a higher critical current. Figure 13 shows the cross-section of a single filament formed using this center-wire-in-tube approach.

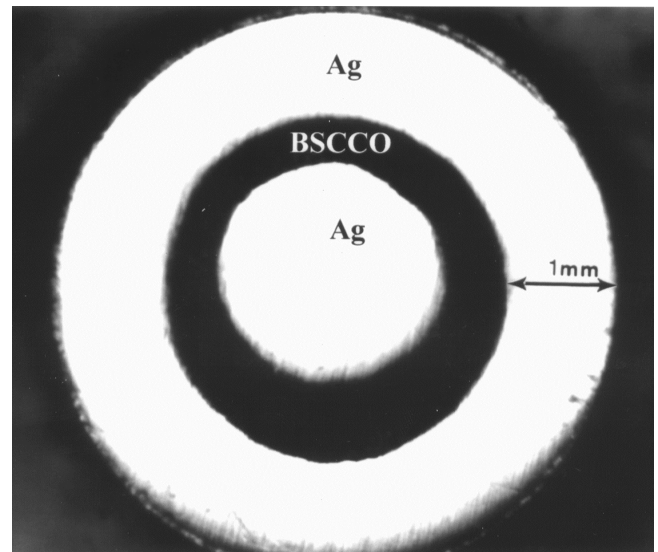

Fig. 13. Cross-section of a monofilament CWIT wire. Photo courtesy of Argonne National Laboratory.

The proponents of CWIT maintain their approach ameliorates problems associated with secondary phase formation in that there is more superconductor available to short circuit around such inclusions. Their argument is illustrated in Fig. 14. The advantages of CWIT are presumably twofold: 1) the overall increase in Ag surface area in contact with the HTSC, and 2) the lower probability of a region of secondary phase formation completely blocking supercurrent in a given filament. Further investigation should reveal if these improvements are indeed realizable.

In the meantime, Figs. 15 and 16 chronicle the improvement of J_C in the traditional multifilament Bi-2223 OPIT conductors with time as the “learning curve” for production method proceeds for the two major American companies now capable of supplying tape in relatively long lengths. These results represent encouraging progress. How long the relatively linear improvement in critical current density can be sustained remains to be seen, but evidence has been presented that regions near the Bi-2223/Ag interface can exhibit a J_C of the order 10^5 A/cm² [27] so, in principle, there is still a long way to go before the full potential of Bi-2223 OPIT/Ag is reached.

It is important to dwell some on the conventions employed to determine reported critical currents by the various laboratory centers and wire manufacturers. Because of the usual presence of flux creep in HTSC materials, especially near 77 K, as discussed previously, the onset of a “critical” current is seldom sharp, and, in fact, generally follows a power law behavior of form $V \sim I^n$, where $n \sim 10-20$ for HTSC materials. For purposes of consistency, most workers now report J_C as that current density which produces an electric field along the tape or wire of $E = 1 \mu\text{V}/\text{cm}$. Such is how the data shown in

Multifilament Transverse Section

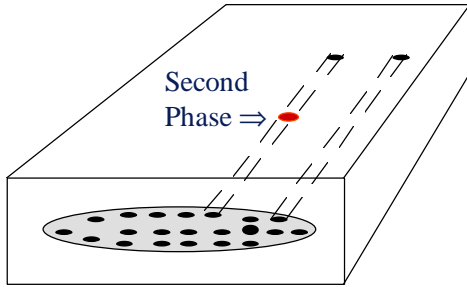

CWIT Transverse Section

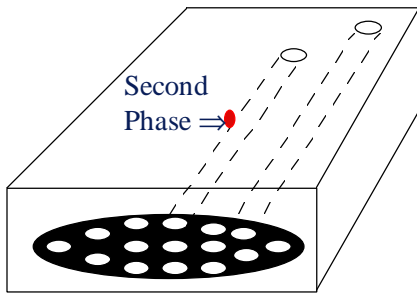

Fig. 14 Upper: In standard OPIT secondary phase blocks transport in filament. Lower: For CWIT secondary phase forms only in a portion of overall HTSC volume. See text for further discussion. Drawing courtesy of Argonne National Laboratory.

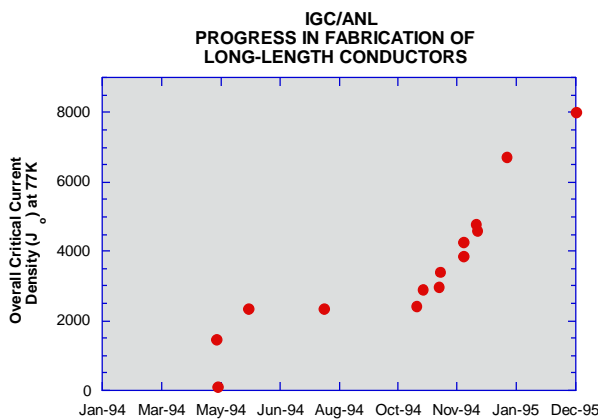

Fig. 15. Overall critical current density, J_o in A/cm^2 , for long lengths of Bi-2223 wire of order 100 m produced by Intermagnetics General Corporation and Argonne National Laboratory as a function date shown. J_o , often called J_E , for “engineering,” is obtained by normalizing the total measured critical current to the total tape cross-section area including the silver, whereas J_c , the “core” or “traditional” critical current density, is I_c divided by the average area of the HTSC filaments (see Fig. 12). Often the engineering critical current density is more meaningful when fill-factor is important, such as in superconducting electromagnets.

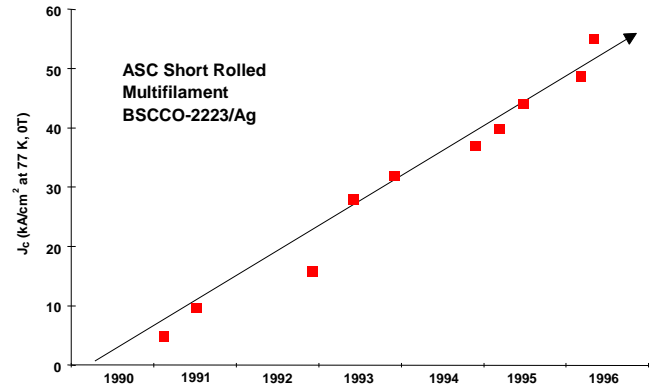

Fig. 16. Core critical current density, J_c in A/cm^2 , for lengths of Bi-2223 tape of several meters produced by American Superconductor Corporation as a function of time shown.

Figs. 15 and 16 were determined. Whether this is reasonable or not depends on the target application. For example, an engineering current density of $8000 A/cm^2$ at a voltage drop of $1 \mu V/cm$ yields a power dissipation density of $8 mW/cm^3$, a seemingly small number. However, for a tape of nominal dimensions $0.5 cm$ wide by $0.5 mm$ thick and $100 m$ long, the dissipation expended to carry $20 A$ in a single tape is $0.2 W$. If we are looking at a cable conductor to transport $4000 A$, the power loss rises to $40 W$ per 100 meters of cable, or $0.4 kW/km$, a nontrivial penalty, especially for a dc cable, or large electromagnet

The electrical specification desired to address almost all applications would be contained in the following expression:

$$V = f(I, T, B, q, w, A, l), \quad (1)$$

where V = voltage drop per unit length,
 I = current,
 T = temperature,
 B = magnetic field,
 q = crystallographic orientation,
 w = frequency,
 A = cross-sectional area,
 l = wire length.

Unfortunately, HTSC wire manufacturers have yet to begin reporting all aspects of wire electrical performance as outlined by the above expression, making it difficult to design to specific applications. An example specification available for the “conventional” definition of J_c in terms of T , B and θ typical of presently available Bi-2223 OPIT tape is given by Figs. 17 and 18. These figures show $J_c(T, B)$ normalized to $J_c(77 K, 0 T)$ for applied magnetic field in directions parallel and perpendicular to the plane of the tape. Because of the texturization features induced by the OPIT process and micaceous behavior of the Bi-2223 structure, the in-plane direction roughly corresponds to ab-plane or plane of the copper oxide sheets, and thus out-of-plane to the c-axis direction (see Fig. 9). The “wet spaghetti” effect is clearly seen in Fig. 18 as J_c rapidly

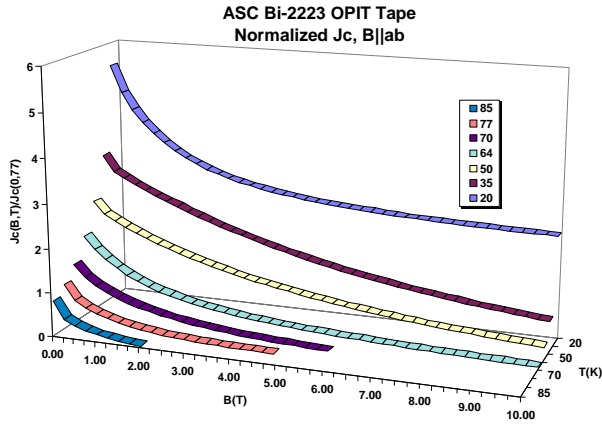

Fig. 17. Normalized J_C vs temperature and magnetic field applied in the plane of the tape (ab-direction). Data courtesy of American Superconductor Corporation.

drops with increasing magnetic field. The self-field produced by current flow in the tape is generally in the ab-plane, which is the “best” direction for retention of critical current properties. This will usually be the case for the majority of power applications, especially cables and solenoidal electromagnets. In the latter, however, fringe fields at the coil ends will have a significant c-direction component which will limit the overall performance. It is possible to mitigate these “end effects” with appropriate winding designs at such places.

One should also note the rapid increase in $J_C(T, 0)$ below 77 K, almost doubling at roughly the nitrogen ambient pressure solidification point. This has important implications with respect to several applications as will be discussed subsequently.

The cost/performance targets for HTSC OPIT tape are currently a topic of much discussion. The units usually employed are dollars/kiloampere \times meter, which reflect not only the basic manufacturing cost per unit length, but I_C (or more correctly, I) as a performance index. The cost/performance is a direct function of the independent variables in Eq. (1) and can be generally expressed as

$$C/P = \$/I \quad \hat{I} = \$/I \quad g(V, T, B, \mathbf{q}, \mathbf{w}, A, l), \quad (2)$$

where C/P is in $\$/kA \times m$ and $g(\dots)$ is the inversion of Eq. (1) with respect to current, I .

The community has generally accepted a DOE target cost/performance figure of 10 $\$/kA \times m$ at 77 K and 0 T based on an argument that this is approximately the price for “high quality” Nb_3Sn wire at 4.2 K and 0 T, with the proviso that a “customer” would be more than willing to pay the same price for a product which operates at the much higher and accessible temperature of liquid nitrogen. Whether this is realistic

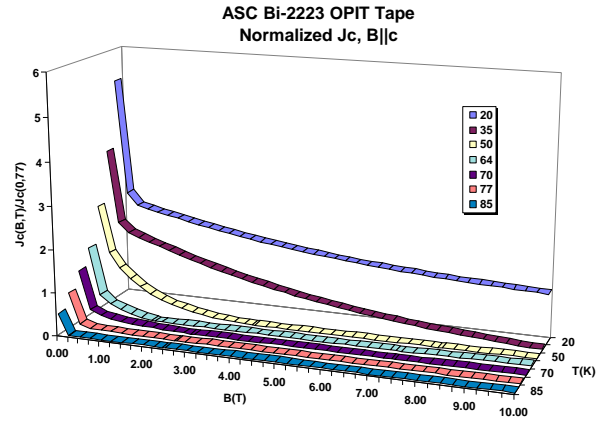

Fig. 18. Normalized J_C vs temperature and magnetic field applied perpendicular to the plane of the tape (c-direction). Data courtesy of American Superconductor Corporation.

remains to be seen. It is worth doing a simple “sanity check” by merely calculating the cost/performance with respect to the Ag component of OPIT tape.

Let us take the nominal dimensions given in Fig. 12 for a typical OPIT tape with an HTSC fill factor of 50% (aggressive) carrying 100 A (77 K, 0 T, optimistic at this time) and a silver open market price of 152.70 $\$/kg$ (4.75 $\$/troy\ oz$) as the basis of such an estimate. We then arrive at a C/P of roughly 20 $\$/kA \times m$ for the silver component alone! Since the price of silver is unlikely to go down appreciably in the foreseeable future, the C/P must be driven down by an increase in I_C . Some manufacturers believe 500 A is eventually possible for the nominal dimensions considered here, which would reduce the Ag-component C/P to 4 $\$/kA \times m$ still leaving only 6 $\$/kA \times m$ to cover HTSC materials and overall manufacturing costs, not exactly a lot of “wiggle room.” It seems unlikely the OPIT wire target of 10 $\$/kA \times m$ will be attainable for some time. There is more bad news. As pointed out already, the convention of determining I_C as that sample current which results in a voltage drop of 1 $\mu V/cm$ may yield intolerable losses in many applications, thus requiring the derating of the operating current. The good news is that due to the power law behavior of the I-V characteristic a voltage drop several orders of magnitude lower than 1 $\mu V/cm$ can be reached at an operating point only 10-20% below the nominal I_C with a concomitantly equal increase in price. There is another factor to consider as well – very few applications will actually be operating at the boiling point of liquid nitrogen because of difficulties inherent in handling flow of a two-fluid system. Most applications requiring a liquid nitrogen cryogen, such as an HTSC cable, will operate at a single-fluid point in the N_2 phase diagram, mostly likely under several atmospheres of pressure and around 66 K, a few degrees above the freezing point of N_2 . As can be seen from Fig. 17, the C/P of OPIT Bi-2223 tape would improve by almost a factor of two at such an operating temperature.

This discussion only enforces the need for wire manufacturers to begin releasing specifications inherent in Eqs. (1)

and (2) above, so that potential users can intelligently proceed with end use designs.

A question that often arises is, “Why use superconductors at all? Why not just cool aluminum or copper in liquid nitrogen?” It is therefore useful to compare the performance of a superconductor to that of normal metals cooled to an equivalent operating temperature. From time to time, projects have been undertaken to evaluate particular cryoconductor applications. For example, about 15 years ago the Central Research Institute for the Electric Power Industry (CRIEPI) in Japan studied the efficacy of liquid nitrogen refrigerated aluminum ac underground transmission cables, and the US Air Force looked into liquid helium cryo-aluminum generators as a possible on-board aircraft electrical supply system.

In order to carry out such a comparison between superconductors and cryoconductors and avoid an “apples-and-oranges” situation, one must establish a common point of performance for both. Given the convention of determining critical current in HTSC superconducting wire when a certain voltage drop is observed, a natural benchmark to use is a cost/performance comparison at equivalent volumetric power dissipation levels. Table I does just that in the temperature range 77-80 K for copper, aluminum and silver at a loss level of 0.015 W/cm^3 , a value obtained assuming an HTSC wire capable of an engineering current density, $J_E = 15,000 \text{ A/cm}^2$ determined at the conventional voltage drop of $1 \mu\text{V/cm}$. J_E^V and J_E^W are the “engineering critical current densities” under conditions of constant volume and power dissipation with respect to the HTSC benchmark, respectively.

With the exception of Ag, the other two common wire metals compare quite favorably with the HTSC C/P target of $10 \text{ \$/kA}\cdot\text{m}$. Of, course, the wire area for aluminum or copper would have to be almost 50-fold larger to carry the same current, e.g., to carry 150 A would require an HTSC wire approximately 1 mm in diameter and around 7 mm for aluminum or copper – not too bad, actually. The fact that copper and aluminum can compare so favorably to HTSC is another reason to reconsider the $1 \mu\text{V/cm}$ standard for determining I_C . The strong power dependence of the I-V characteristic is the main advantage of HTSC – the voltage drop criteria should be set an order of magnitude lower.

2) *Generation II – Textured YBCO Coated Conductors:* Figure 10 reminds us that at 77 K, Y-123 should be very robust in high magnetic field because of its large irreversibility

TABLE I

COST/PERFORMANCE FOR COMMON WIRE METALS AT $15 \text{ mW/CC DISSIPATION}^a$

Metal	ρ Ωcm	D g/cm^3	Price $\text{\$/g}$	J_E^V A/cm^2	J_E^W A/cm^2	C/P $\text{\$/kA}\cdot\text{m}$
Cu	2.5×10^{-7}	8.92	0.20	4.00	245	7.21
Al	2.4×10^{-7}	2.70	0.15	4.17	250	1.66
Ag	2.9×10^{-7}	10.5	15.3	3.45	227	705

^aPower dissipation defined as equivalent to an HTSC wire transporting $15,000 \text{ A/cm}^2$ sustaining a voltage drop of $1 \mu\text{V/cm}$, or 15 mW/cm^3 . J_E^V is the volume equivalent current density with respect to the HTSC wire, and J_E^W the power dissipation equivalent.

field, H_{IRR} . Moreover, it is known from epitaxial thin film studies and melt-processed single grains that a J_C well in excess of 10^6 A/cm^2 is possible. Why has it not then been employed as a wire material? Essentially, the difficulty has been that the same aspect of its crystal structure that results in good magnetic field performance, that is, its lower degree of two-dimensionality, creates problems when attempting to process it by the OPIT method. The lack of a micaceous layer, as present in BSCCO, results in a random arrangement of copper-oxygen a-b planar intersections between individual grains.

A typical basal-plane intersection for YBCO and the consequences for magnetotransport response with increasing grain angle boundary is depicted in Fig. 19 [28]. The deleterious effect on critical current at high magnetic field for high angle grain boundaries, always present in ceramic YBCO, is clear. If somehow the average grain boundary angle could be kept to 15 degrees or less, YBCO might become a potential wire embodiment.

We should mention that it is not yet entirely clear why large angle grain boundaries result in the observed “weak link” behavior in superconducting properties. There is evidence that some oxygen depletion occurs in the CuO “chain” components of YBCO (see Fig. 9). There are also indications that significant strains exist at grain boundaries which may impede the passage of a supercurrent. In addition, one might speculate that if the symmetry of the superconducting pair state of an HTSC is indeed d-wave (vide supra), decreasing overlap of the superconducting wave functions between adjacent grains with increasing grain boundary angle, and hence forming an ever weaker link, may be an intrinsic property of these materials. It is important to understand the source of the wide angle grain boundary weak link, as clues may be found to reduce its negative effect on superconducting magnetotransport properties. At present, the only path for improvement is to explore methods to keep the angle between adjacent YBCO grains small.

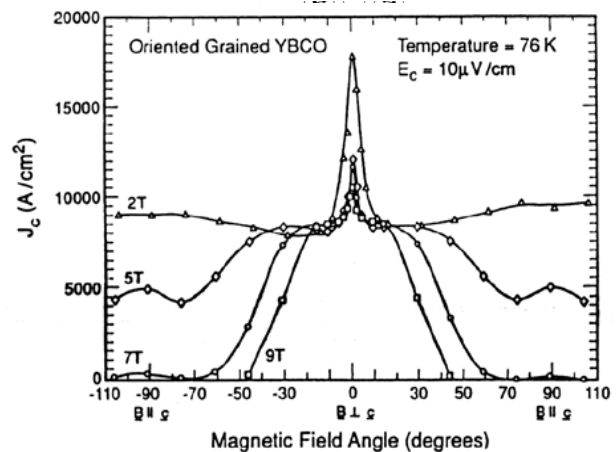

Fig. 19.: Transport critical current density J_C as a function of the angle between magnetic field and the a-b plane of bulk grain-oriented YBCO at 77 K [28].

One procedure for grain alignment in YBCO that works well is to “melt process” the ceramic form using methods

analogous to zone refining of semiconductors. An initial region of the material is brought to its melting point and this region is drawn slowly along its remaining length. This method produces very good J_C characteristics in high magnetic field, but is painfully slow – of the order of a few mm/hr – hardly practical for manufacture on a kilometer-length scale. The best magnetotransport characteristics are achieved in epitaxial films of YBCO which are essentially single grain structures. Figure 20 summarizes the improvement of YBCO transport properties as a function of processing. Once again, however, epitaxial films require rigid (and expensive) single crystal substrates, not a practical framework for a wire technology. Nonetheless, the successes of both melt-processing and epitaxial film growth demonstrate extraordinary results can be obtained for YBCO once high angle grain boundaries can be eliminated and suggest possible paths to bring this about, especially those that might be quasi-epitaxial in nature.

In the mid-1970s, a film deposition technique was developed by workers in the IBM Research Division whereby the material being deposited could be preferentially oriented in a given crystallographic direction [29]. An auxiliary rare gas ion source was used to bombard a buffer layer along a particular crystallographic axis as it was being laid down. This method, known as “ion beam assisted deposition,” or IBAD, favors the preferential growth of particular biaxially textured crystallographic deposits depending on the angle of incidence of the assist beam with respect to the substrate plane. The actual mechanism by which a given direction is favored is still uncertain – there is evidence to support a channeling effect as well as differential resputtering of the film by the assist beam as it grows. In any event, a subsequently post-deposited film on such a prepared buffer layer might possess a high degree of orientation with subsequent small angle boundaries between adjacent crystallites, providing other conditions, such as closely matching lattice constants and thermal expansion factors, were adequately satisfied. This technique was applied by Iijima, et al. [30], and by Reade, Berdahl and Russo [31], to the deposition of yttria-stabilized zirconia (Y_2O_3 -stabilized ZrO_2 , or YSZ) on thin flexible metal tapes, such as stainless steel or Ni alloys (Hastelloy), in the hope of providing a platform for post-deposition of oriented YBCO. The basic layer configuration with typical thickness values for the components is shown in Fig. 21 (usually a very thin, ~ 200 Å, layer of CeO_2 is interposed between YSZ and YBCO for improved lattice constant matching). Note that, unlike OPIT-produced wire, these tapes can be wound with the superconductor in *compression*, a very attractive feature for electromagnet applications. A measure of the relative orientation of the YBCO grains is given by the FWHM of the x-ray diffraction ϕ -angle scan peak of a Miller index reflection containing both perpendicular and in-plane components. Figure 22 depicts the dependence of J_C on

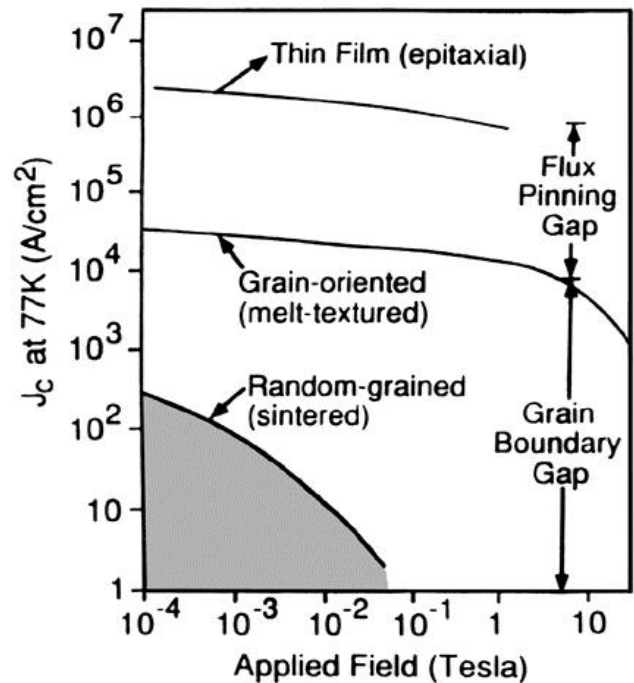

Fig. 20. Improvement of J_C in magnetic field at 77 K for YBCO as a function of synthesis and processing.

ϕ -angle FWHM [32] and confirms the behavior expected from Fig. 18 and the results of Dimos, et al. [33] on weak-link behavior in YBCO epitaxial films grown on bicrystal substrates of varying intersection angles (recall Fig. 19).

Figure 23 shows the highest critical current in boiling nitrogen obtained to date in short lengths (~ 4 -5 cm) of 1 cm wide IBAD samples produced by the Los Alamos National Laboratory group, and Fig. 24 contains the dependence of J_C on magnetic field and direction with respect to the tape plane compared with proton-irradiated Bi-2223.

The vastly improved performance with respect to OPIT is apparent. A major question, of course, is whether the IBAD-

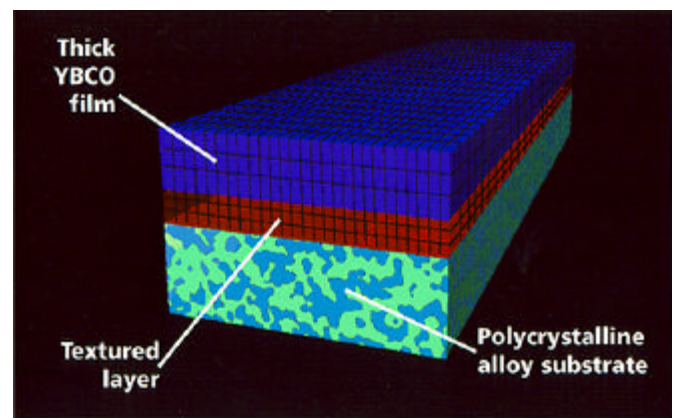

Fig. 21. Cross-section of a prototypical YBCO/YSZ/Hastelloy tape.

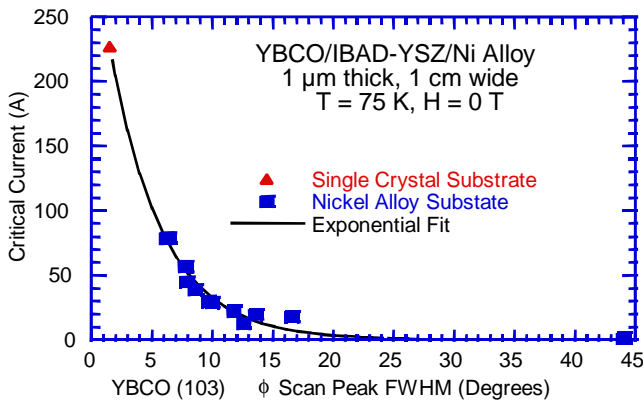

Fig. 22. Dependence of J_c on the ϕ -scan YBCO (103) peak FWHM [32].

buffered, YBCO thick film approach is scalable to manufacturing levels of thousands of kilometers per year at a competitive cost. A preliminary analysis [34] using as a basis a 1970s study proposing the manufacture of Nb_3Sn tape by thin film deposition methods, properly adjusted for current cost-of-funds, labor costs, materials procurement and capital plant, indicate that production costs comparable to presently marketed volumes of LTSC wire ($NbTi$ and Nb_3Sn) are achievable. This study assumed critical current levels now within reach ($\sim 3 \cdot 10^6 \text{ A/cm}^2$) with thin film thicknesses of the order given in Fig. 21 produced at deposition rates obtainable in volume-production-size vacuum coating chambers such as used today in the magnetic disk storage industry. One possible manufacturing visualization is given in Fig. 25. This figure shows how either slower deposition rates, or the need for thicker films should the target J_c prove impractical, can be managed by employing a multiple pass arrangement

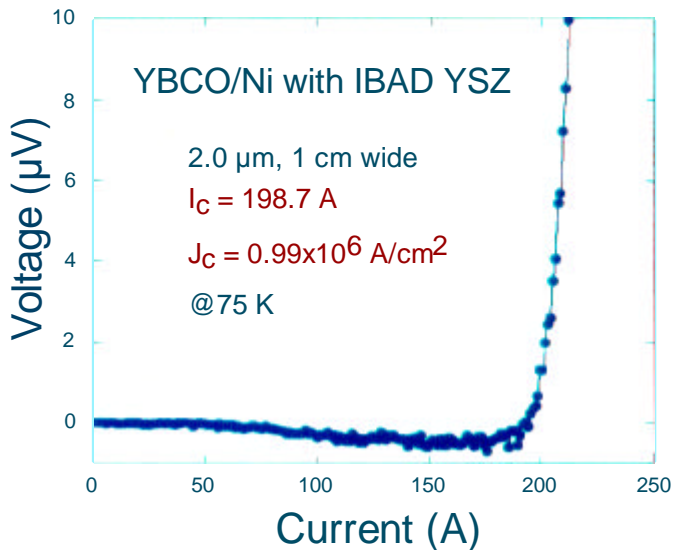

Fig. 23. V-I characteristic of a short sample of YBCO/IBAD-YSZ/Ni tape with an I_c of almost 200 A. The small negative dip just prior to threshold is due to contact heating effects [32].

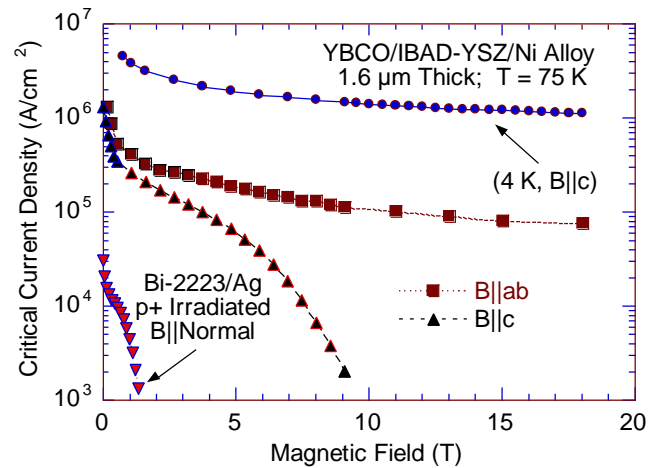

Fig. 24. J_c vs. applied magnetic field for short samples of $1.6 \mu\text{m}$ IBAD tape as a function of magnitude and orientation with respect the tape plane, compared with proton-irradiated Bi-2223 OPIT wire [32].

The analysis of Ref. 31 estimates that for volumes in excess of 80,000 km/yr, the basic manufacturing cost could be as small as $\$5/\text{kA}\cdot\text{m}$ (77 K, 0 T).

An alternative, and potentially more economically attractive, approach to manufacturing biaxially-oriented YBCO coatings on flexible metal tapes is under exploration. Many common metals undergo texturization under standard metallurgical treatment such as rolling, drawing, stamping and thermal annealing. Transition metals with fcc crystal structures and noble metals are particularly amenable to uniaxial and biaxial texturization. The process has been in use even before the turn of the century. Essentially, the tendency of grain boundaries in cubic metals to slip more readily along specific crystallographic directions is empirically exploited to produce the desired texture. With regard to HTSC tapes, workers at Hitachi [35] textured Ag tapes subsequently depositing Tl-1223 by spray pyrolysis. Only partial success was obtained due to the tendency of the HTSC basal plane constants to better match the [110] direction of Ag thus producing a fairly large quantity of 45° grain boundaries.

In 1994 efforts began at the Oak Ridge National Laboratory to explore the possibility to use oriented Ni as a tape substrate to induce biaxial texturization in both the buffer

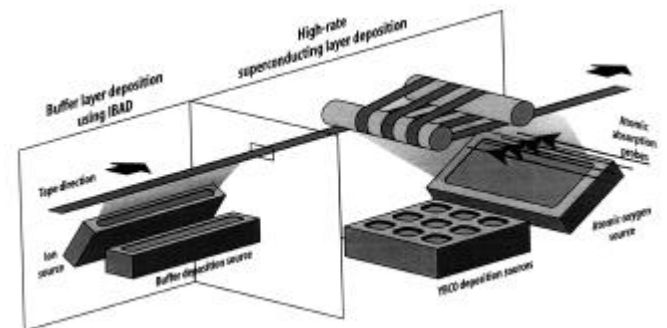

Fig. 25. Proposed high-rate manufacturing process for YBCO wire tape using ion-beam-assisted-deposition (IBAD) [34].

layer, necessary to prevent diffusion of Ni into the superconductor overlayer, and post-deposited YBCO as well [36]. The

basic configuration is essentially that of Fig. 21, except that the IBAD process is not required. ORNL terms their method RABiTS[®], for “rolling-assisted biaxially-induced textured substrate.” Their most recent critical current densities, $J_C \approx 700,000 \text{ A/cm}^2$, are approaching the best IBAD levels, with similar robustness in magnetic field.

The successful commercialization of the coated conductor approach could bring a dramatic reduction in cost/performance compared to Generation I OPIT/Ag technology; however, a number of key issues remain to be solved. Perhaps paramount among them is that, to date, only pulsed laser deposition (PLD) has yielded the best results for both the buffer and YBCO layers on flexible substrates, irrespective of the texturization method, IBAD or metallurgical deformation, employed. What would seem optimal is a high-rate non-vacuum deposition technique. Recent results obtained depositing YBCO on single crystal substrates utilizing metal-oxide-decomposition (MOD) and photon-assisted MOCVD have yielded substantial critical current densities, for which there is reason to believe can be maintained on transfer to oriented flexible tapes. Nevertheless, the high precursor cost and low material capture of the latter method are definitely a challenge. One should mention that electron beam deposition, although requiring vacuum, is capable of very high rates over large areas, and a collaboration has just begun between the 3M Corporation and Stanford University to investigate its possibilities. Here the major open question is oxygenation of the growing film at high deposition rates of the constituent metal cation components. Behind all approaches is the problem of maintaining high J_C with increasing film thickness, especially beyond $1 \mu\text{m}$, in order to increase I_C and consequently J_E . J_C is almost always higher in films less than 300 nm, perhaps due to the proximity of substrate interface pinning centers whose effect decreases with increasing film thickness.

Next, rapid and uniform buffer layer growth, by either IBAD or straight deposition on a previously textured tape, has not yet been optimized. Recent efforts to increase IBAD deposition of YSZ rates to the range thought required for manufacturing have not been successful. MgO, by virtue of its ability to grow rapidly without further assist after seeding the first 10 nm by IBAD, may be a candidate to replace YSZ [37]. Within the last six months, ORNL has obtained excellent x-ray pole figure data on YSZ e-beam deposited on meter-scale lengths of deformation textured Ni tapes [38], but, so far, no report has been made on the superconducting properties of any subsequently deposited YBCO overlayer. An unanswered question for all approaches involves the migration of transition metal atoms through the buffer layer at the high substrate deposition temperature required for YBCO – why does it have to be so thick (200-500 nm) – does the diffusion occur along grain boundaries?

Finally, there is the issue of the flexible tape substrate itself. At present the thickness of choice is 5 mils (0.005”),

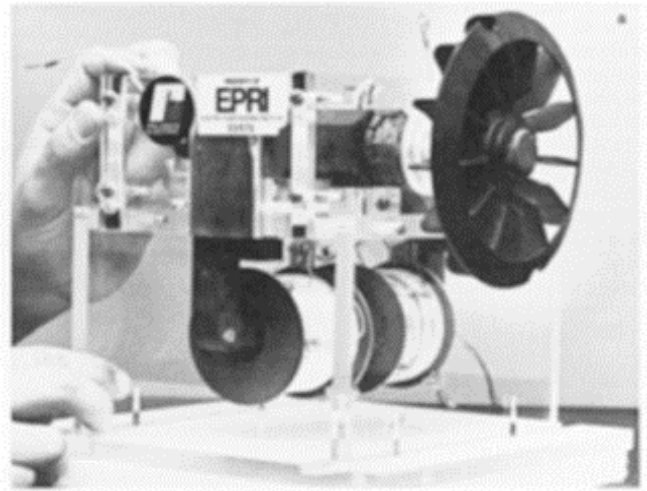

Fig. 26. First HTSC motor, ca. 1988, an EPRI/Reliance Electric Corporation collaboration. The stator coils were immersed in liquid nitrogen poured into the transparent Plexiglas container.

simply because thicker material is easier to handle under laboratory conditions, with some results available on 2 mil material. It is to be hoped 1 mil will become the manufacturing standard. If so, engineering critical current densities in the range $80,000 \text{ A/cm}^2$ should be attainable. Whereas a number of transition metal alloys, e.g., Hastelloy, nichrome, are suitable for IBAD deposition, to date the optimum material for deformation texturization has been nickel, a ferromagnet, which raises several questions with respect to ac and magnet applications which have yet to be addressed.

C Rotating Machinery

In Section II we discussed a few of the issues involved in LTSC rotating machinery, among these the fact that the advantages of superconductivity in these applications is only realized at very large unit sizes and energy consumption and production. The arrival of high temperature superconductivity did not essentially change any of these factors.

1) *Motors.* These considerations notwithstanding, it is interesting that almost the first non-trivial demonstration of the promise of the discoveries was to build a small dc motor. This demonstration unit is shown in Fig. 26, well-remembered by the author. A Helmholtz pair wound with wire supplied by the Argonne National Laboratory which was immersed in liquid nitrogen. An iron core supplied a magnetic field to a conventional rotor electromagnetic.

Figure 27 illustrates how far we have come in just seven years. Shown therein is the design of the Reliance/DOE Phase I Superconducting Partnership Initiative (SPI) motor which underwent bench testing in the spring of 1996.

The design parallels a conventional synchronous ac motor containing a 3-phase stator coupled to a dc-excited air-core rotor. Because of the relative high self-magnetic field seen by the rotor, the assembly is cooled by He gas at a temperature around 30 K. The rotor was wound with Bi-2223 OPIT/Ag

125 HP DOE/SPI HTS Motor Salient Features

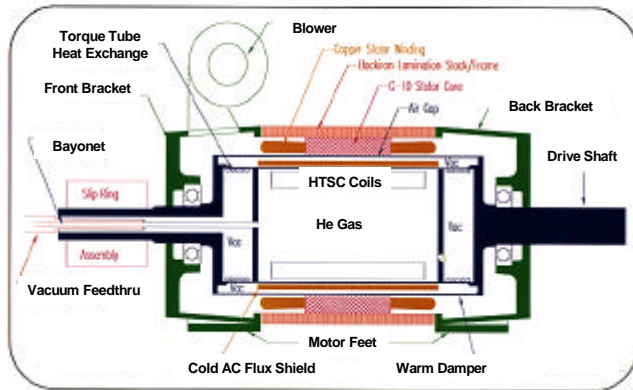

Fig. 27. 125 hp Reliance/DOE synchronous motor produced under sponsorship of the DOE Superconducting Partnership Initiative. This motor actually exceeded 200 hp on bench testing.

tape supplied by American Superconductor Corporation. The He gas cryogen was circulated at a temperature of 25-30 K through a mid-shaft bayonet fitting similar to that pioneered by previous LTSC projects. The prototype of Fig. 27 actually delivered 200 hp on bench test, which was limited solely by the test facility available at the time. It was calculated that perhaps the unit might have been capable of handling a nearly 400 hp peak load.

The success of this project resulted in DOE awarding a Phase II SPI to Reliance and American Superconductor totaling 21 M\$ cost-shared for three years last summer to develop a 1000 hp pre-commercial model, designed to lead subsequently to development of a 5000 hp product offering by the year 2000.

Large synchronous motors are very efficient, bordering on 97% for 100 hp and greater. Superconductivity could raise that by perhaps 1-1.5%, a seemingly trivial amount. However, studies show that as much as 30% of the electricity generated in the US is consumed by electric motors of greater than 1000 hp, so that considerable savings in energy on a national scale (Fig. 3, vide supra) could be achieved should superconducting motors capture even a small portion of that market. Nevertheless, it is important to recall our earlier comment that devices powered by large motors, such as fluid pumps and fans, are much less efficient than the motors themselves, primarily because the constant speed inherent in a synchronous motor often does not match the variations in load encountered by the fluid prime mover. Thus, the refrigeration required for a superconducting motor offers another opportunity – a totally cryopower-integrated variable speed unit with a superconducting rotor whose stator frequency is controlled by highly efficient cooled silicon power electronics to best match load requirements at all times.

2) *Generators.* Opportunities for deployment of superconducting generators remain small at present for reasons explained earlier. The very large economies of scale offered by

superconductivity applied to generation are not required in the current global power scenario. This could change if, for example, carbon-emission-driven global warming were proven to be occurring, an event which certainly would revive nuclear power, the natural target for superconducting generators. Even if carbon emission turns out not to be the problem as currently conceived or that it can be controlled, global fossil reserves are predicted to be exhausted by about the middle of the next century. Thus, there is a scenario for superconducting generator technology, but not for some time, the present Super-GM project in Japan notwithstanding. There is reason to expect that once the first-phase 70 MVA project is completed, the second 200 MVA phase may be deferred indefinitely.

At the end of 1995 a DOE/GE/IGC phase one generator SPI program came to an end. The project consisted of a single “racetrack” coil containing about 2 km of Bi-2223 OPIT/Ag tape which carried 30 A at 20 K. Presently, there are no plans for a future HTSC generator program in the US. The possibility of developing a retrofit HTSC rotor for replacement of the present conventional component in already installed generators as maintenance schedules permit has received some discussion. However, most utilities either maintain their own refurbishing shops or contract out periodic bearing replacement and coil rewinding as needed. Only about 12-15 generator rotors in the greater than 100 MVA class are completely replaced every year in the US. Hydroelectric generators are even more reliable because of their slower rotational speed. In the whole history of the Hoover Dam since its commissioning in the mid-1930s, just one out of some dozen units has been replaced. Although there still remains certain performance advantages to superconducting generators beside increased efficiency and economy of scale, e.g., improved transient response because of the lower inertial rotor mass and perhaps built-in fault current limiting features, the overall prospect for the widespread development and deployment of LTSC or HTSC generators remains bleak for some time to come.

D Power Cables

As pointed out earlier (see Section II on LTSC power cables), near-lossless transmission of electricity has long been seen as the ultimate application of superconductivity. The advent of long lengths of BSCCO tapes has given birth to ambitious cable projects in Japan (Sumitomo, Furakawa, supported by Tokyo Electric Power), the US (EPRI with Pirelli Cable, Southwire Corporation) and Europe (Siemens, BICC). There are presently ongoing discussions in Japan concerning the establishment of a national program for cable development sponsored by MITI to be carried out through a joint effort by the International Superconductivity Technology Center (ISTEC) and Japanese industry.

We will discuss here the early stages of the EPRI/Pirelli/DOE ac underground transmission cable SPI. Recently, a 50 m cable conductor successfully carried 3300 A

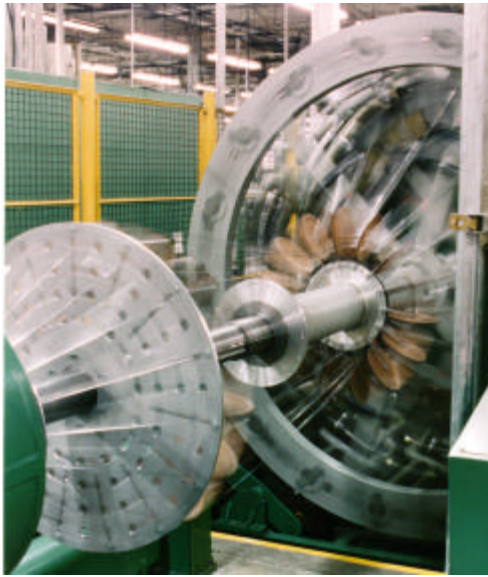

Fig. 28. Cable conductor assembly being wound on a hollow flexible former using Bi-2223 OPIT/Ag wire tape similar to that shown in Fig. 12. Photo courtesy of Pirelli Cable USA.

dc at 77 K. Figure 28 shows the hollow flexible former being wound with ASC Bi-2223 OPIT/Ag tape to form the cable conductor. A breakaway close-up of a completed conductor assembly is shown in Fig. 29.

The prototype cable design, which packages the conductor assembly of Fig. 29, is sketched in Fig. 30. It consists of a three-phase circuit enclosed in an 8 inch (206 mm) steel tube, the most common housing for urban underground transmission/distribution systems in the United States. The basic cable design follows closely the current conventional size and construction to allow as much use of present manufacturing plant as possible without extensive retooling. The same outside cable diameter as current conventional cables (~85 mm) was chosen to permit their retrofit with a superconducting model as an initial market entry strategy. The cable design shown in Fig. 30 represents essentially a direct replacement of the present copper conductor and its nearest layer of electrical insulation with superconducting and cryogenic components. The original performance specifications called for a 30 m cable to operate at a 115 kV voltage level and carry 2000 A_{RMS} of current, or a power delivery capacity of 400 MVA within a three-phase circuit. Because of the continuing improvement in wire performance, it is expected that these targets will be easily exceeded when the completed prototype begins high voltage and cryogenic qualification testing later this year. The central conductor comprises a hollow, flexible stainless steel former, approximately 25 mm in diameter, spirally wound with 150 tapes (10 layers, 15 tapes per layer, tape dimensions 4.5 mm wide by 0.25 mm thick, each layer counterwound at 45 degrees) of ASC Bi-2223 OPT/Ag wire. To meet the stated cable specification, each individual tape must sustain a critical current of around 15 A in lengths of approximately 100 m (as of the writing of this paper, critical

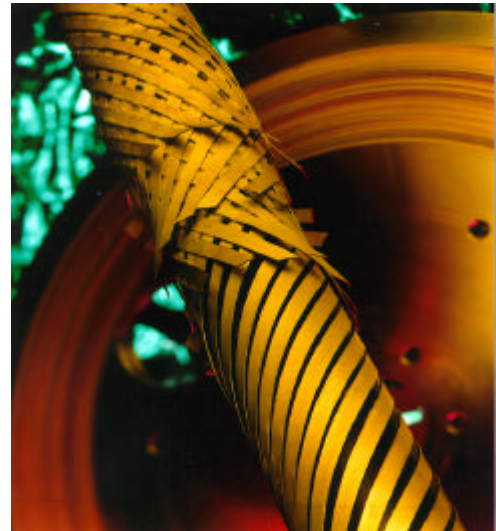

Fig. 29. Finished cable conductor assembly showing first four layers of helically wound tape. The diameter of the conductor is approximately one inch. Photo courtesy of Pirelli Cable USA.

currents in excess of 30 A have been obtained). The multi-tape conductor is enclosed in two concentric corrugated stainless steel tubes, containing between the inner and outer a “super-insulation” layer, about 12 mm thick, of crinkled aluminized mylar tapes which is vacuum-pumped to around 10⁻⁴ Torr. Liquid nitrogen is pumped at a rate of several l/s under pressure and reduced temperature through the central stainless steel former of one phase and returned through those of the two co-phases.

This particular cable design is by no means ideal. It is not coaxial; that is, it does not contain a superconducting shield against eddy current loss in the surrounding metallic addenda (steel pipe, stainless steel slider, etc.). Moreover, its lack of such a shield exposes each conductor phase to induced eddy current losses from the other two, a particularly pernicious situation as the neighboring phase magnetic fields will have a significant c-axis crystallographic component at the site of the third phase (recall how rolling and drawing planarize Bi-2223 so that the a-b axes are in the plane of the tape with the

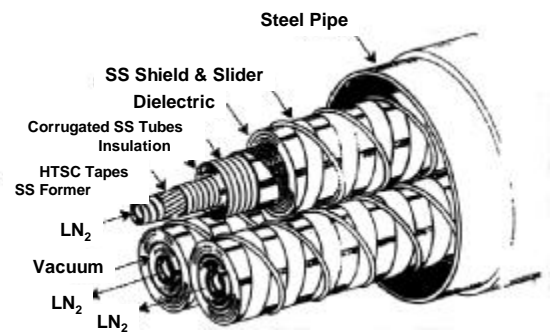

Fig. 30. EPRI/Pirelli/DOE superconducting ac underground cable project. The figure shows a complete 3-phase circuit contained in a steel pipe. Note that LN₂ flows down one phase and returns through the other two.

c-axis orthogonal). As discussed previously (see Fig. 18), the c-axis direction is especially sensitive to magnetic field. The co-phase ac loss has recently been measured [39] and was found to essentially double the total ac loss over that induced by the self field of a single phase.

Figure 31 expresses the component and total losses calculated for this design including 14 W/W of cooling power, but exclusive of the two-phase hysteretic losses shown by the open bar on the right. When these losses are included we arrive at about 360 W/m×cct or 900 W/km/MW for a 400 MVA three phase circuit. This figure is about 30% higher than a conventional 300 MVA copper conductor cable, but the power delivered is equivalently higher as well. Keep in mind these are early design figures dating from 1992, and the current capacity of BSCCO tape has increased by at least 60% in the meantime, and proportionally even more for long tape lengths.

E Other Applications

Space does not here permit a detailed discussion of a myriad of other possible power applications for high temperature superconductivity, e.g., fault current limiters, transformers and macro- and micro-superconducting energy storage (SMES) devices. Several review articles touching on these areas have appeared within the last year, and the reader is referred to them [40, 41, 42] for further information. However, we will make few brief observations here ourselves.

1) *Fault Current Limiters (FCL)*: Fault current limiters are devices designed to absorb the shock of a grid “short circuit” for a brief period (5-6 cycles) to allow time for recovery before breaker trip-out. Various designs for superconducting FCLs have been around for a long time. The present DOE SPI program (Lockheed-Martin, LANL, Southern California Edison and EPRI) involves a semiconductor rectifier bridge biased by

a superconducting inductor containing a dc current set to the desired fault level. A 2.4 kV, 2.2 kA single phase unit has been successfully tested at an SCE substation. Historically, it has been difficult to interest US utilities in FCLs of any technology, given the general resiliency of our grid to fault conditions with respect to Europe and Japan where much more attention is being given to this application.

2) *Transformers*: HTSC technology offers several advantages when applied to power transformers, especially lighter weight and smaller footprint, elimination of potentially hazardous cooling oil, and built-in fault current protection. In the US, IGC and Waukesha Corporation have begun a program to develop a three-phase 138 kV, 30 MVA unit utilizing Ag dip-coated with Bi-2212 operating in the 20-30 K temperature range. In April, 1997, Asea Brown Boveri (ABB) installed a three phase 630 kVA HTS transformer in a substation of the Geneva utility company in Switzerland. The ABB transformer uses Bi-2223 OPIT/Ag wire from American Superconductor.

3) *Large SMES*: There are currently no plans for the construction of a large HTSC SMES anywhere. Anchorage Electric and Babcock & Wilcox have under construction an LTSC SMES. Interestingly, the world’s largest SMES is Fermilab’s Tevatron particle collider, where the stored energy, around 350 MJ, is, on periodic shutdowns, returned to the local utility, Commonwealth Edison, resulting in a substantial reduction in the facility’s electric bill.

4) *Small SMES*: Several companies have small HTSC SMES designs under consideration, but the mainstay remains the 1 MJ unit manufactured by Superconductivity, Inc. (SI), recently acquired by American Superconductor. Somewhere between 5 and 15 units are in operation at any given time, mostly at military locations. It remains to be seen whether small SMES will develop into a major power quality technology. It is believed at EPRI that small SMES could become an important component in the future of the Flexible AC Transmission System (FACTS) [43].

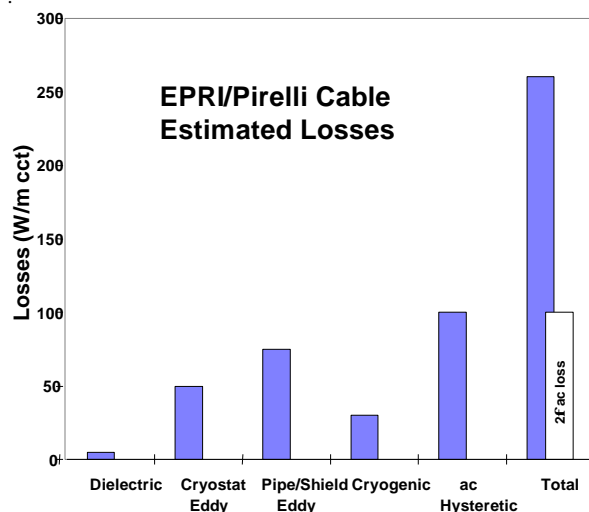

Fig 31. Distribution of losses in the EPRI/Pirelli room temperature dielectric (RTD) cable. Shown on the far right (open bar) are ac hysteretic losses induced by fields from the other two co-phases which the total does not include

IV. FUTURE

Remember Fig. 1 in the Introduction which pointed out the correlation between standard of living and electricity production for those nations in various stages of economic development? What scenarios can we envision to supply the energy needs of members of the emerging block as they begin the climb up that curve? One possibility is given in Fig. 32 which shows a envisioned network of gas pipelines throughout Asia linking major natural gas reserves to developing energy consumption centers within the region. One is immediately struck by a single overriding observation – the end use areas are invariably far from the fuel deposits, in almost every case

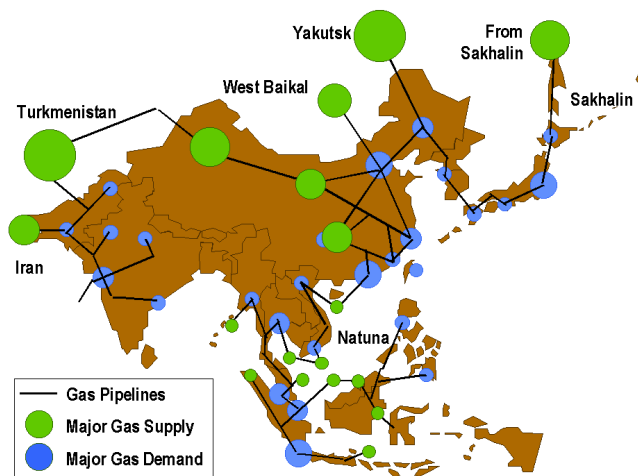

Fig 32. Location of major Asian natural gas fields with respect to population and industrial demand centers. Connecting lines are not actual gas pipelines, but potential routing corridors. Drawing courtesy of Royal Dutch Shell.

more than 500 miles. One can make similar arguments in the case of coal and hydro resources – the exploitable near-in-reserves to the load centers have already been tapped.

Most of the gas will be used for electricity generation in and around end-use areas, the majority large population centers. This will require construction of generation facilities in already dense and congested locations. There is an alternative – generate the electricity at the gas wellhead and wheel it to the load center via a high-capacity direct current transmission line.

This is not a new idea. Some 200-odd high voltage dc (HVDC) transmission lines exist throughout the world which connect widely distanced source and load centers. HVDC overcomes the limitations of alternating current transmission over long distances (a 750 mile overhead transmission line is good quarter-wave antenna for 60 Hz; a 30 mile cable is a large capacitor requiring about as much power to charge it as it delivers). For example, proposals have been put forward to wheel huge amounts of hydroelectricity – Amazon to coastal Brazil, Ghana to North Africa, Turkey to the Middle East, Hudson Bay to Northeast US – by HVDC. In fact, contracts were recently signed to build hydro plants in Indonesia for electricity delivery to Southeast Asia.

It should be clear by now that alternating current and superconductivity do not fit together without substantial loss – direct current is a much better way to transport electricity, and, we can do it at much lower voltages than HVDC, because we can use much higher currents. So why not consider an Electricity Pipeline instead of a gas pipeline?

At EPRI we are considering just such a concept [44], centered around the structure sketched in Fig. 33. In fact, the Electricity Pipeline would be just one component of a total cryoelectric system consisting of the transmission pipe, fed by a six- or twelve-pole (to simplify rectification, filtering and

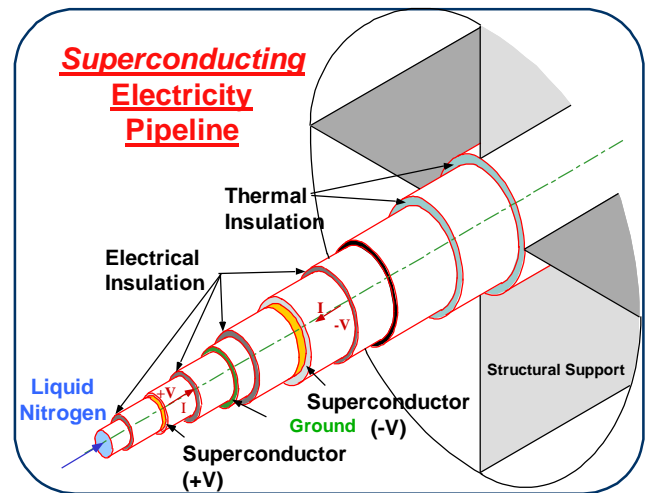

Fig 33. The Electricity Pipeline: A bipolar “coaxial cable” consisting of concentric wrappings of HTSC tape separated by electrical insulation and a normal metal ground conductor which could also be used to moderate quench and fault situations. The outer shell would be 70 cm in diameter, typically made of ABS, and the inside components are drawn roughly to scale. Between the shell and first layer of insulation would be a low level vacuum. Nominally, the electrical capacity would be ± 50 kV to ground on the superconductor pair transporting 50 kA through the load, or a net power transfer of 5 GW. The pipe would be built in 50 m rigid sections and field-assembled either in a shallow trench or on pylons.

reduce ripple) superconducting rotor generator farm located at the fuelhead, through a cryocooled rectifier station ending in a similarly cryocooled inversion station at the load center, all protected with superconducting fault current limiters – a “cryopowered dream team machine,” if you will!

There’s even more. The principal liquid nitrogen cryostation will be located at the generation site. Depending on the nature of the fuel source, its products may also benefit the combustion process as well. Liquid nitrogen is obtained by liquefaction of the air. What do we do with the liquid oxygen (LOX) obtained as a byproduct? If the fuelhead is a coal field, coal gasification is a natural pre-combustion processing choice for such requires large amounts of LOX to supply the gasification column. If it is natural gas or oil, it may be possible to increase turbine combustion temperatures and thus efficiency at the same time moderating NO_x emissions through dilution of its concentration in the combustion stages.

That’s the dream – now what about the reality? The observant reader will note that there’s lots of problems here. To mention a few, we have ac losses due to ripple, the notoriously difficult design problem of dc FCLs, the strategic exposure to failure either by accident or political/military action, and there are more, I’m sure. Our ongoing study will be looking into these issues, but there has been completed a preliminary economic analysis of the electricity pipe itself compared to the alternatives of gas and HVDC.

A detailed description of the analysis is inappropriate here and we will only cover the major aspects. An electrical capacity of 5 GW, or ± 50 kV at 50 kA was targeted. The construction materials considered for the design of Fig. 33 are of

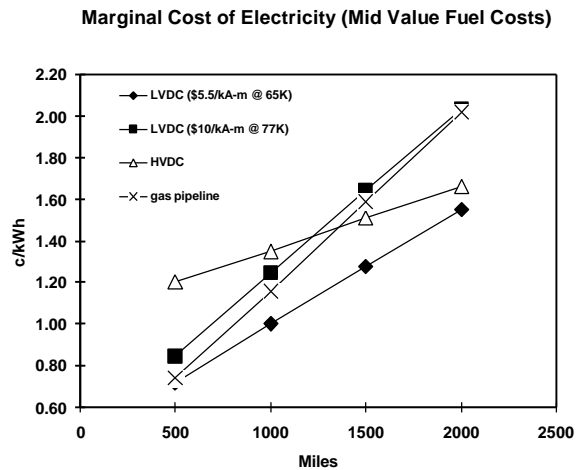

Fig. 34. Comparison of the add-on transmission cost of four power wheeling scenarios for transmitting 5 GW as a function of distance between generation source and load center. The add-on, or marginal cost, depends on fuel cost because this enters into the electricity cost of running the refrigeration and vacuum pumping stations. Note sensitivity of LVDC choice to wire C/P.

a usual nature and currently available, even the superconductor, whose performance parameters were taken from Fig. 17. An operating temperature of 65 K to be provided by single phase liquid nitrogen was selected and materials, dimensions and ambient vacuum (10^{-4} Torr) chosen to allow 1 W/m heat in-leak for removal. This figure also allowed for ac losses due to ripple which was estimated from the measurements of Daney, et al. [39] on the ac cable conductor referred to earlier. A maximum temperature rise to 1 K above 65 K was selected before recooling was required to maintain leveled superconductor performance. A baseline length for the pipeline of 1610 km (1000 miles) was used to calculate total support requirements. These considerations could be met by a generation-end liquifier feeding 21,600 l/hr (a coal gasification scale plant size) of LN_2 at 65 K into the pipe supported by incremental cooling stations every 10 km. To maintain vacuum, pumping stations would operate every kilometer. These stations would be powered by taps off the dc line every 100 km resulting in total load of about 1.5 MW.

Figure 34 compares the marginal, i.e., add-on, cost of four transmission scenarios to transmit 5 GW of power for given distances from generation source to load center. The marginal cost is defined as the capitalized and operating cost differential of the transmission system (the entire “hotel bill,” refrigeration, electrical costs – which depend on fuel costs, etc.) to be added onto the cost of generation equipment capital and operation and fuel (here a mid-range fuel cost between projected future extremes is used).

It is clear that the competitive position of the LVDC Electricity Pipeline is a close function of wire C/P. Figure 34 shows it to be a clear winner if the DOE target C/P is achieved at 77 K and then adjusted to the operating point of 65 K according to Fig. 17. Although we stated earlier our misgivings about realizing the DOE target in the near future, the scenario for the Electricity Pipeline is far enough in the future (5-10 years at least) that we can be confident either

higher critical currents in Generation I Bi-2223 OPIT/Ag or the successful commercialization of Generation II coated conductors will be able to meet, and mostly likely, exceed it. The “cryopower dream team machine,” of which the Electricity Pipeline is a component is still under study and will be completed next year.

One last thought – eventually the remaining fossil fuelhead reserves will be exhausted (or global warming precludes their use), their remote location would make quite suitable sites for nuclear plants.

V. SUMMARY

I have tried to strike a tone in this paper which should be interpreted by the reader as “soberly optimistic” with respect to the evolving role superconductivity will play in the future of the electricity enterprise. Both endeavors are experiencing “interesting times” as the ancient Chinese proverb puts it – the advent of high transition temperature materials for superconductivity has led to a renaissance in its application to power technology through practical wire development, and the electricity industry is undergoing deregulation, restructuring and competition in the developed nations, and explosive growth in the emerging ones. No one questions the central and vital role of electricity in modern society, but the future technology to be required will reflect a number of economic, social and political issues, such as fuel supply and prices, environmental impact and maintenance of the public transmission system infrastructure. The place occupied by superconducting power technology in the Electricity Paradigm will depend on how these issues play out. Two example scenarios focused on North America will illustrate what I mean. It is estimated that the United States, Canada and Mexico have 50 more years of natural gas reserves that can be delivered at more or less present prices adjusted for inflation. The US has a vast network of gas pipelines, unique in the world, that supply a major portion of its population. The last decade has seen a quiet revolution in efficiency improvements and size and cost reduction in combined cycle combustion gas turbine technology. These factors combine to make possible the distributed generation of electricity on a local scale not previously conceived, sited in neighborhood substations, factories, commercial centers – perhaps even private residences. What is the role of superconductivity in this scenario? Quite probably there will be a reduced need for high voltage transmission/distribution cables, with more emphasis on superconducting transformers and power quality and storage devices. But now suppose incontrovertible scientific evidence emerges that carbon-emission-driven global warming is indeed underway, and continued massive exploitation of the earth’s fossil fuel reserves is now longer tenable. Under such conditions, many experts expect a return to central nuclear-fission generation, a scenario where superconducting generators and power transmission would occupy center stage. Of course, there are other possibilities – a green society based on renewable electric generation with hydrogen production, storage and fuel cell generation, for example – that would require a different flavor and deployment of superconductivity.

I have also attempted in certain sections of the paper to be frankly provocative to encourage open discussion within the applied superconductivity community of several important issues, especially with respect to HTSC wire pricing and application-directed performance specifications. The Electricity Pipeline just discussed falls into the same category – to encourage new thinking about how to apply superconductivity to rapidly evolving global electrification.

In 1988, about one year after the “Woodstock of Physics,” an article appeared in the MIT Technology Review entitled, “Superconductors: The Long Road Ahead,” authored by Sy Foner and Terry Orlando [45]. Their thoughtful and reflective views were much needed at the time to dampen some of the extreme claims then being made over the promise of the new discoveries. Now almost ten years have past and much encouraging progress has occurred toward power applications brought about by the development of practical HTSC wire. Nevertheless, I think it appropriate to end my paper by paraphrasing the closing remarks of theirs which still apply today – all indications are that superconductivity and electric power have entered a dynamic new phase – but a great deal remains to be done.

ACKNOWLEDGEMENT

Many individuals contributed to my education in applied superconductivity which (hopefully!) has been reflected in a modest way by this paper. Those requiring special mention are David Larbalestier, Don Von Dollen, Tom Schneider, Alex Malozemoff, Bob Sokolowski, Marty Maley, Harold Weinstock, Dick Blaugher, Bob Hammond and Ted Geballe. Tom Sheahen’s excellent introductory text (from which I unabashedly purloined some of the figures used in this article!) became my Bible. Thanks go to Steve Foltyn, Paul Arendt, Jeff Willis, Amit Goyal, Don Kroger, Dave Christensen and Balu Baluchandran for generously sharing their data and insights with me. Susan Schoenung and Bill Hassenzahl helped design the “Electricity Pipe.” The continuing support of my colleagues at the Electric Power Research Institute, particularly Fritz Kalhammer, John Maulbetsch, John Stringer, Chauncey Starr and Gail McCarthy, is deeply appreciated.

REFERENCES

[1] H. Kamerlingh Onnes, Leiden Comm. **120b**, **122b**, **124c**, (1911).
 [2] J. G. Bednorz and K. A. Mueller, Z. Physik **B64**, 189 (1986).
 [3] A. Schilling, et al., Nature **363**, 56 (1993).
 [4] T. G. Berlincourt, IEEE Trans. Mag. **MAG-23**, 403 (1987).
 [5] R. M. Bozorth, H. J. Williams and D. D. Davis, Phys. Rev. Letters **5**, 148 (1960).
 [6] J. E. Kunzler and B. T. Matthias, US Patent 3,281,736, October 25, 1966.
 [7] T. G. Berlincourt and R. R. Hake, Bull. Am. Phys. Soc. **7**, 408 (1962).
 [8] T. P. Sheahen, “Introduction to High-Temperature Superconductivity,” (Plenum, New York, 1994).
 [9] EPRI Report, “300 MVA Superconducting Generator,” 1982, available from the EPRI Publications Service
 [10] “Power Applications of Superconductivity in Japan and Germany,” World Technology Evaluation Commission Report, ed. D. Larbalestier, 1997.
 [11] E. B. Forsythe, Supercon. Sci. Technol. **6**, 699 (1993).
 [12] LANL dc Cable Report; see also DOE/Philadelphia Electric Company dc Distribution System Study; both reports available from DOE.

[13] H. Shaked, et al., “Crystal Structures of the High- T_C Superconducting Copper Oxides,” (Elsevier Science, Amsterdam, 1994); obtainable from Argonne National Laboratories. It is interesting to note that several of the layered copper oxide perovskites later found to be high temperature superconductors had been synthesized as early as the 1950s. The structural and chemical nature of these compounds were extensively studied by French, American, Russian and Indian researchers over the years, but until Bednorz and Mueller, none had attempted to measure their low temperature transport properties. High temperature superconductivity is one of modern science’s more sardonic instances of a discovery which occurred well after its proper time!
 [14] R. J. Cava, et al., Nature **367**, 252 (1994), A. F. Hebard, et al., Nature **352**, 600 (1991).
 [15] J. Bardeen, L. N. Cooper and J. R. Schrieffer, Phys. Rev. **108**, 1175 (1957).
 [16] P. W. Anderson, Science **235**, 1196 (1987); M. K. Beasley, Proc. Applied Superconductivity Conference, Boston, 1994.
 [17] M. K. Wu, et al., Phys. Rev. Letters **58**, 908 (1987).
 [18] C. W. Chu, Proc. Applied Superconductivity Conference, Baltimore, this issue.
 [19] P. M. Grant, Nature **386**, 115 (1997); Nature **381**, 559 (1996).
 [20] Beyers, et al., Appl. Phys. Letters **53**, **432** (1988).
 [21] W. Zhang, E. A. Goodlin and E. E. Hellstrom, Supercon. Sci. Technol. **9**, 211 (1996).
 [22] A. Schilling, et al., Nature **362**, 56 (1993).
 [23] K. Isawa, et al., Proceedings of the 6th International Symposium on Superconductivity (26-29 October 1993, Hiroshima).
 [24] L. Krusin-Elbaum, et al., Appl. Phys. Letters **64**, 3331 (1994).
 [25] L. Krusin-Elbaum, et al., to be published.
 [26] Y. Feng, et al., Physica **C192**, 293 (1992).
 [27] M. Lelowic, et al., Supercond. Science & Tech. **9**, 201 (1996).
 [28] J. W. Ekin, K. Salama and V. Selvamanickam, Appl. Phys. Lett. **59**, 360 (1991).
 [29] L. S. Yu, J. M. E. Harper, J. J. Cuomo, and D. A. Smith, Appl. Phys. Lett. **47**, 932 (1985).
 [30] Y. Iijima, N. Tanabe, O. Kohno and Y. Ikeno, Appl. Phys. Lett. **60**, 769 (1992).
 [31] R.P. Reade, P. Berdahl, and R.E. Russo, Appl. Phys. Lett. **61**, 2231 (1992).
 [32] S. Foltyn, et al., reported at Spring Meeting, MRS, San Francisco, April 1995; see also P. M. Grant, Nature **375**, 107 (1995).
 [33] D. Dimos, et al., Phys. Rev. Letters **61**, 218 (1988).
 [34] K. B. Do, et al., Bull. Am. Phys. Soc. II **40**(1), 13 (1995).
 [35] D. N. Zhang, et al., J. Appl. Phys. **77**, 5287 (1995).
 [36] A. Goyal, et al., MRS Spring Meeting, San Francisco, 1-2 April 1997, Abstract R1.2, p. 301.
 [37] R. H. Hammond, et al., to be published
 [38] R. Paranthamans, reported at the 9th International Symposium on Superconductivity (October, 1996, Sapporo).
 [39] D. E. Daney, et al., Proc. Applied Superconductivity Conference, Baltimore, 1966, appearing this issue.
 [40] T. Moore, “Power Applications for Superconductivity,” EPRI Journal, July/August 1996.
 [41] G. B. Lubkin, Physics Today **49**, 48 (1996).
 [42] R. F. Service, Science **271**, 1804 (1966)
 [43] N. G. Hingorani and K. E. Stahlkopf, Scientific American **269**, 78 (1993).
 [44] S. Schoenung, W. Hassenzahl and P. M. Grant, to be published.
 [45] S. Foner and T. P. Orlando, MIT Tech. Rev., Feb/Mar 1988, p.36.